

ELECTRONICTM

Service & Technology

JANUARY 1983/\$2.25

Service Atari video games

Digital techniques in audio and video



**Color comes
to logic analyzers**

PTS CORPORATION

No. 2 in a series

Magnavox 703616-1

Module Update

***PTS automatic updates
calm the vertical jitters and
defeat the black shadow.***

Vertical jitter in the 703616-1 was eliminated with a jumper wire from Pin-9 to Pin-22 on the "D" panel. This wire by-passes the contact resistance at Pin-9. In addition to making the automatic update, PTS includes a notice to servicers with each module detailing the hookup procedure.

Black shadow was commonly resulting from an inadequate grounding system. The automatic addition of a jumper wire at the R3/C2 junction allows the professional service dealer to ground the panel to the chassis frame and eliminate the black shadow effect. After automatic updates are made each module is fully repaired and air tested in a live chassis.

You'll find PTS quality rebuilt modules with automatic updates at over 1,500 locations nationwide. For the name of the location nearest you and your free copy of the PTS Price and Technical Information Guide, use the reader response card or write:
PTS Corporation, P.O. Box 272,
Bloomington, IN 47402.

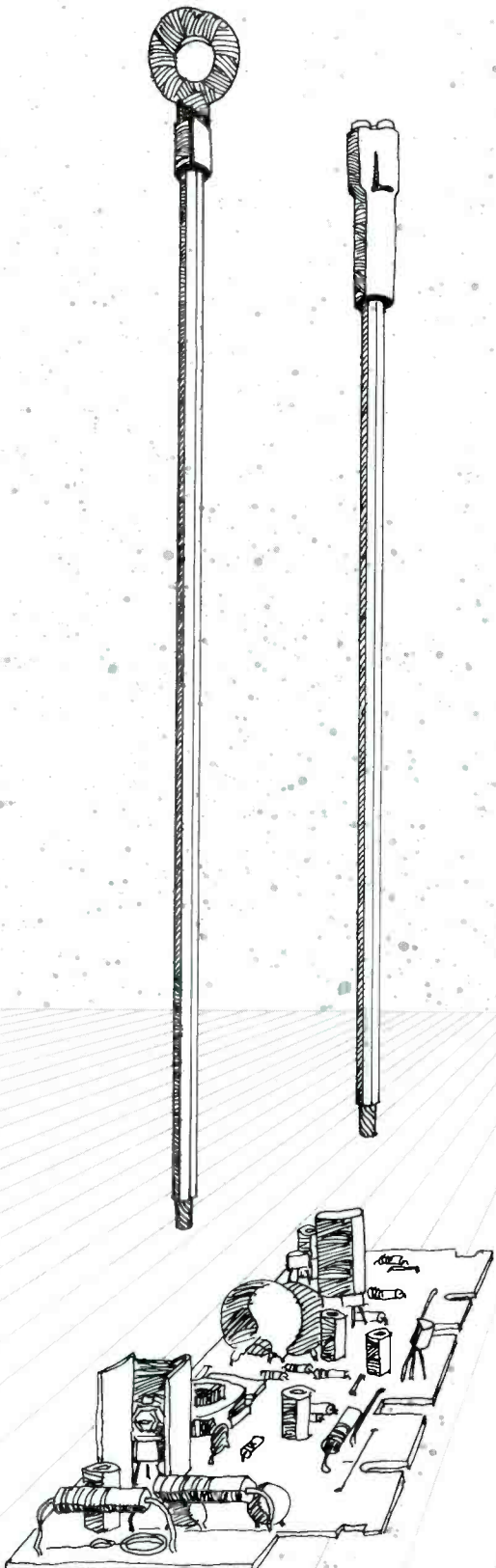

Circle (1) on Reply Card

"I'll tell you what it takes to succeed in VTR repair service."

"It takes know-how, and the right equipment to do the job. You obviously have the know-how, or you wouldn't be reading this magazine. The equipment? The same brand that factories use to build and test sets on production lines... LEADER!"

You need professional test equipment for a professional repair job.

Leader gives you test signal sources for every conceivable video and audio application—reliable and easy-to-use instrumentation that keeps you right on track. Audio sine/square wave generators cover 10 Hz to 1 MHz with low distortion.

To see what you're getting, Leader's LBO-517 50 MHz dual-trace oscilloscope is a natural. Put the input to a circuit on one trace, the output on the other, and actually see where distortion

occurs, how much, and when it's corrected! You'll find more features on this oscilloscope than on many others regardless of price or manufacturer's claims. Or choose from a dozen other models.

The Leader frequency counter—in a rugged metal housing—can be used to adjust chroma frequency and vertical or horizontal synch circuits. Leader's large, bright fluorescent displays are easy to read. To round out your test bench, you'll need a wow and flutter meter, mirror-backed scale ac voltmeter, and a good quality field strength meter... all from Leader.

With Leader, you've got what it takes...

... to do the job right and build a reputation as the person to see when problems develop. With Leader on your test bench, there's no limit to the jobs you can tackle, the service you offer... or the extent of your potential income.

Two-year warranty. Evaluation units.

A history of high reliability permits Leader to provide a generous two-year warranty... backed by factory service depots on the East and West Coasts. A free, trial use of Leader instruments is available to all qualified companies.

Call toll-free (800) 645-5104 to request: an evaluation unit, our 40-page catalog, the name of your nearest "select" distributor and additional information about how you can succeed in VTR Service.

For VTR professionals who know the difference.

LEADER
Instruments Corporation

380 Oser Avenue
Hauppauge, N.Y. 11788 (516) 231-6900
Regional Offices:
Chicago, Los Angeles, Dallas.

Circle (4) on Reply Card

Photograph of test bench taken at Orien-Tech, Inc. a factory authorized service center.

The how-to magazine of electronics...

ELECTRONIC

Servicing & Technology

January 1983
Volume 3, No. 1



The Design Automation Division of Tektronix has introduced a digital analysis system with a color CRT display, possibly the first use of a color display in test and measurement. See "Technology," a new department this month, on page 8. (Photo courtesy of Tektronix.)

12 Digital techniques in audio & video

By Carl A. Bentz

Digital audio and video, using analog-to-digital or digital-to-analog devices, is turning up in home entertainment equipment.

16 Methods of equalizing tape recordings

By Carl Babcoke, CET

Frequency equalization is achieved with circuits using capacitors and resistors that increase or decrease the frequency response at specific frequencies.

28 Servicing GE projection TVs

Adapted by Carl Babcoke

Specialized information and troubleshooting tips for servicing the General Electric model 45EP1000 widescreen receiver include drawings and photographs.

44 A control system primer

By Joe Carr

Examples of electronic control systems in the home are the thermostat, the phase-locked loop in your television and the electromechanical control system in VTRs.

50 Servicing Atari video games

By Kirk Vistain

A typical repair on an Atari video game, by a technician experienced with working with them, takes about 15 minutes, and you probably already have all the necessary test equipment.

Electronic Servicing & Technology (USPS 462-050) (with which is combined Electronic Technician/Dealer) is published monthly by Intertec Publishing Corp., 9221 Quivira Road, P.O. Box 12901, Overland Park, KS 66212-9981. Second Class Postage paid at Shawnee Mission, KS 66201. Send form 3579 to P.O. Box 12592, Overland Park, KS 66212-9981.

Departments

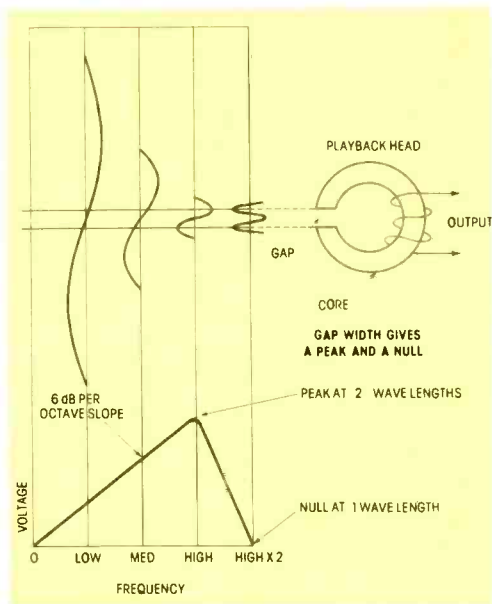

Page 16



Page 28

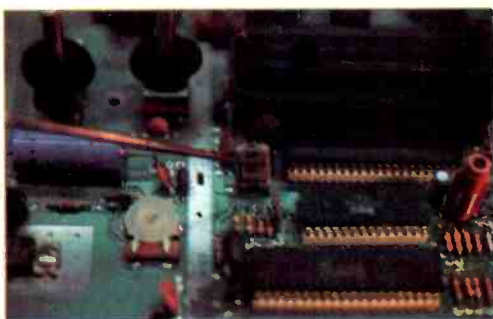

Page 50

- 4 Editorial
- 4 News
- 8 Technology
- 10 Troubleshooting tips
- 14 Photofacts
- 26 Readers' Exchange
- 43 Books
- 57 Products
- 60 Literature

Next month...

New tools for new technology. The introduction of developments such as PC boards and ICs has brought new requirements to tool manufacturers. This sampling of new tools includes low-heat soldering equipment, anti-static devices and testing accessories.

There is nothing permanent except change.
Heraclitus (C540-C480BC)

Change is inevitable. That fact was recognized by the ancients. Even then people observed the motion of the sun across the sky, the constant change from day to night and back to day again. They noted the waxing and waning of the moon, the rising and falling of the tides, and the majestic procession of the seasons. Change is the very essence of growth. Nothing stays the same. Things grow or decay, but they change.

In today's world, change has begun to take place so rapidly that it's hard to keep up with it. Edison invented the phonograph about 100 years ago (and took out a patent on the vacuum tube to boot). In the relatively few years since then, vacuum tubes were perfected and gave rise to a number of industries. The vacuum tube in its turn has become all but obsolete since the development of the transistor and its offspring, the entire family of integrated circuit devices. ICs in turn, have allowed bringing electronics products to a state of perfection undreamed of in Edison's day, and have spawned or been instrumental in yet further incredible changes: microcomputers, the space program, satellite communications. It's enough to make your head spin.

The staff of **ES&T**, struggling along with everyone else to gain some degree of perspective on all of this technological development, developed the idea for a department in the magazine that would present brief reports on technological developments that are particularly germane to **ES&T's** readers. This new department, premiering this month, is called *Technology*. We plan to cull the best and most interesting reports of advances in electronics and related areas from the many that we receive.

For example, in this issue, we're covering the development of an electronics test instrument that is capable of reading out in color. As far as we know, this is the first use of color in such a device. According to the manufacturer, the use of color will enhance the interface between the operator and the instrument, and potentially reduce human errors significantly.

In the February issue, the new department will feature a report on a development in LCD technology by a British firm that has made it possible to build an oscilloscope with a flat LCD readout

in place of the familiar CRT. It is, of course, extremely dangerous to speculate in a medium as permanent as print, but is it possible that this will be the first step in replacing the last remaining vacuum tube in electronic equipment, the CRT, with a solid-state (more or less) device?

We hope that these reports will help readers by alerting them to electronics technological developments that may affect them tomorrow, next week or next year.

We're changing too.

In thumbing through the pages of this issue, you may notice that we've made a few changes in **ES&T**; we hope for the better. We've changed the design of our department headings to make them more attractive and to make them fit better with the look of the magazine. We've also changed the department titles, just a little, to make them more appropriate, and a little shorter. We have in no case changed the information to be presented. *Calendar of events*, has been changed to, simply, *Events*. And we haven't done away with *Electronic Scanner* or *Association News*; we've combined both departments and are calling them *News*. We've also dropped the word "New" from two of our departments, changing *New Products* and *New Literature* to simply *Products* and *Literature*, respectively. We hasten to add, however, that this is a change of name *only*. All products and literature described in these departments will be the latest announced by manufacturers.

Getting to know you.

One of the projects that we initiated last year has already begun to bear fruit: the questionnaires that have been appearing in **ES&T**. Thousands of readers have been kind enough to take the time to fill out these questionnaires, and we're beginning to get a better idea of what kinds of work our readers get involved in, how they received their training and how they go about servicing a malfunctioning unit. This information is already helping us immeasurably in planning what kind of articles to publish. We're sure most readers are interested in finding out a little more about other readers, so during this year, we plan to run several reports on what the responses to those questionnaires revealed. Stay tuned.

Nils Conrad Persson



News

Magnavox PMX AM-stereo exciter receives FCC type acceptance

The key broadcast equipment element in the PMX AM-stereo radio system by Magnavox has been granted type acceptance by

the FCC.

Acceptance of the AM-stereo exciter, the unit that prepares AM radio transmissions for stereo reception, enables AM broadcasting stations in the United States to put the Magnavox PMX

2SC1413A

Horizontal Output Transistor Equivalent to ECG® 238



ALSO REPLACES

ECG 165	C1894
C1172B	D200
C1174	D201
C1295	D348
C1308K	D350
C1309	D368
C1358	D627
C1454	D649
C1875	D380
C1893	D663
C1922	D869
C1942	D870

\$2.09
(10-99)

\$1.69
(100 & Up)

And Many Others Too Numerous To List!

Replacement for ECG® 152

VCBO: 100V **39¢**
10-99
IC: 4A
PC: 30 W **29¢**
100-Up

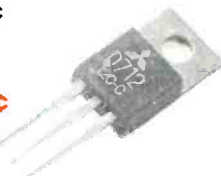

Also replaces:
D313, C1060, C1061,
C789, D526, C1419

2SD712

Replacement for ECG® 153

VCBO: 100V **45¢**
10-99
IC: 4A
PC: 30 W **35¢**
100-Up



Also Replaces:
B507, A670, A671,
A489, B596, A755

2SB682

Your Complete Electronic Parts Source
Most Orders Shipped Within 24 Hours • Compare Our Prices



4 1/2" Hi Fi Tweeter

Deep cone for accurate mid-range and high frequency reproduction

- 30W RMS
- 8 Ohms
- 2 kHz-17 kHz Response

\$4.95
10-up

PART NO.
CE 478 **\$5.95**
1-9



4' Dual Audio Patch Cable

2 RCA plugs on each end

PART NO.
DPC-4

\$1.09
1-9 **89¢**
10 or more



15' Coiled Stereo Headphone Extension Cable

PART NO.
HEC-25

\$2.39
1-9 **\$2.25**
10 or more

SPECIALS GOOD
THRU JAN. 31, 1983

1-800-543-3568

NATIONAL WATS LINE

705 WATERVLIT AV. DAYTON, OHIO 45420



CALL FOR YOUR FREE COPY
OF OUR 1983 CATALOG TODAY

1-800-762-3412

OHIO WATS LINE

IN DAYTON OHIO CALL 252-5662

AM-stereo system on the air.

Johan C. Koppier, Magnavox spokesperson, said "Magnavox will market radios capable of receiving the PMX stereo signal in 1983. Magnavox AM stereo radios will be available in several styles and at key price points to enhance consumer acceptance. We can meet the market need because of our corporate access to one of the world's largest manufacturers of radio receivers."

The Magnavox PMX system and systems by two other AM stereo proponents have recently undergone testing by Delco, manufacturer of radios for all General Motors automobiles. Delco is expected to express a preference after evaluation of the tests.

AEMC announces hotline for customer questions

The AEMC (Advanced Electrical Measurements & Controls) Corporation has recently established a toll-free technical assistance hotline. Customers calling this WATS line will gain immediate access to an AEMC electrical engineer who can provide valuable information on using AEMC instruments for specific applications, answer questions about particular electrical problems, or discuss the capabilities of individual instruments for solving unusual problems. The number to call is 1-800-343-1391, and there is no charge for this service.

Tektronix announces trade-in allowance for old scopes

Until May 2, 1983, Tektronix will be offering a broad-based oscilloscope trade-in program that covers all working Tektronix 200-, 300-, 400- and 500-series oscilloscopes. During this program, Tektronix is offering a \$250 trade-in for any complete and operable 500-series oscilloscope (with plug-ins) against the purchase of any complete 7000- or 5000-series package, including plug-ins. A trade-in allowance of \$150 for any 200-, 300- or 400-series portable scope is also being offered against any new 400- or 2300-series portable oscilloscope. The same trade-

in allowance can also be used against a complete 7000- or 5000-series package (with plug-ins).

For further details about this program, contact the Tektronix sales office nearest you. Tektronix sales offices are listed in the yellow pages under "data processing equipment" and "electronic instruments." Or call toll free 1-800-547-1512 to determine the sales office nearest you. (In Oregon, call 1-800-452-1877.)

Data General offers free repairs

Several hundred Data General customers across the United States recently received an invitation to send a printed circuit board to Data General for repair at the company's expense. There is no catch; Data General is even offering to pay for return shipping.

The unusual move is part of the company's plan for acquainting customers with the enhanced capabilities of its two new repair centers.

Worth up to \$350 to each customer, the offer includes a certificate redeemable for the repair of one circuit board at either of Data General's repair hubs in Milford, MA, or Colorado Springs, CO. The offer is open to self-maintenance customers who bought more than \$2000 of the company's spare parts in the last 12 months.

EVIP Club re-elects Rowe; names two new directors

In a move away from recent precedent, the Electronic VIP Club has re-elected Herbert Rowe as president of the club. This is the first time anyone has been elected to a second term since Wilfred Larson, the club's founding president, following the transition from the more free-form Radio's Old Timers. Two new members to the board of directors were also elected: James Kaplan, Cornell-Dubilier Electronics, and Dan O'Connell, Amphenol.

ES&T

ELECTRONIC

Servicing & Technology

Editorial, advertising and circulation correspondence should be addressed to: P.O. Box 12901, Overland Park, KS 66212-9981 (a suburb of Kansas City, MO); (913) 888-4664.

EDITORIAL

Bill Rhodes, *Editorial Director*
Nils Conrad Persson, *Editor*
Carl Babcoke, *Consumer Servicing Consultant*
Rhonda Wickham, *Managing Editor*
Tina Thorpe, *Associate Editor*

ART

Kevin Callahan, *Art Director*
Kim Nettie, *Graphic Designer*

CIRCULATION

John C. Arnst, *Director*
Evelyn Rogers, *Manager*
Dee Manies, *Reader Correspondent*

ADMINISTRATION

R. J. Hancock, *President*
Cameron Bishop, *Publisher*
Eric Jacobson, *Associate Publisher*

ADVERTISING

Greg Garrison, *National Sales Manager*
Jean Jones, *Production Manager*
Mark Raduziner, *Marketing Coordinator*



Member, Audit Bureau of Circulation



Member, American Business Press

ELECTRONIC SERVICING & TECHNOLOGY (USPS 462-050) (with which is combined Electronic Technician/Dealer) is published monthly by Intertec Publishing Corp., 9221 Quivira Road, P.O. Box 12901, Overland Park, KS 66212-9981. Second Class Postage paid at Shawnee Mission, KS 66201. Send Form 3579 to P.O. Box 12952, Overland Park, KS 66212-9981.

ELECTRONIC SERVICING & TECHNOLOGY is the "how-to" magazine of electronics. It is edited for electronic professionals and enthusiasts who are interested in buying, building, installing and repairing home-entertainment electronic equipment (audio, video, microcomputers, electronic games, etc.).

SUBSCRIPTION PRICES: one year \$15, two years \$26, three years \$34 in the USA and its possessions. Foreign countries: one year \$20, two years \$30, three years \$40. Single copy price \$2.25; back copies \$3.00. Adjustment necessitated by subscription termination to single copy rate. Allow 6 to 8 weeks delivery for change of address. Allow 6 to 8 weeks for new subscriptions.

PHOTOCOPY RIGHTS: Permission to photocopy for internal or personal use is granted by Intertec Publishing Corp. for libraries and others registered with Copyright Clearance Center (CCC), provided the base fee of \$2 per copy of article is paid directly to CCC, 21 Congress St., Salem, MA 01970. Special requests should be addressed to Cameron Bishop, publisher. ISSN 0278-9922



INTERTEC PUBLISHING CORP.

©1982 All rights reserved.

The Right Tools.



**Boker[®], Crescent[®],
Lufkin[®], Nicholson[®], Plumb[®],
Weller[®], Wiss[®], Xcelite[®].**

The right tool makes the job easier.
And Cooper makes the right tool for the job.
Whether you're making or mending, cutting or joining,
striking, measuring or stripping, there's a Cooper tool that's
just right. Don't take chances on tools. Specify Cooper
and get 'em right the first time!



The Cooper Group PO Box 728 Apex NC 27502 USA Tel (919) 362-7510 Telex 579497

CooperTools

Circle (6) on Reply Card

The Design Automation Division of Tektronix has introduced the color version of its DAS 9100 family of digital analysis systems, which features a color CRT display.

The DAS 9120 series of color logic analyzers, like the entire DAS 9100 family, are modular digital analysis systems housing both data acquisition and pattern-generation card modules in the same mainframe. The modules, offered in a variety of data widths and speeds, are combined in the mainframe to match the user's application needs. Data acquisition widths of up to 104 channels and speeds to 660MHz give state-of-the-art performance, and the interactive pattern generator allows simultaneous stimulation and acquisition from a device under test.

The DAS 9120 series represents the first use of a color display in test and measurement instrumentation. Studies conducted by the Technology Group, the research arm of Tektronix, show that color significantly enhances the interface between the operator and the logic analyzer. When compared with other forms of information coding, color can reduce human response errors by 80%. Color also offers a decided advantage when applied to tasks such as glitch detection and cursor-base measurements of timing information. In general,

color means quicker instrument setup and faster interpretation of acquired data.

Although new to test and measurement, color has a long and successful history in many different types of display environments. Because the human brain is equipped to process color information, color is a logical choice for encoding complex displays, such as those found in logic analyzers. The aesthetic appeal of color also acts as a deterrent to boredom and fatigue produced by interacting with a monochromatic display.

Three colors—red, yellow and green—were picked for the CRT display as dictated by basic color research at Tektronix and other institutions. The spectral spacing between these colors makes them easy to identify and separate with the human eye. Each color has been applied to specific information on the DAS 9120 series display.

For quick analysis of displayed data, "background" information, such as line labeling, is separated from "foreground" information, such as timing diagram. Programmable menu fields are color separated from other fixed fields, improving operator setup times for data acquisition and pattern generation. Menu prompts and cursors are color-coded in red for faster recognition and interpretation.

All acquired state and timing data are displayed in yellow, with supporting background information in green. Items that require focused attention, such as cursors and error messages, are presented in red. Glitches on the acquired data are highlighted in green.

The DAS 9120 series also incorporates other new features, which are available for the entire DAS 9100 family. "Delta time" automatically calculates time intervals between selected sample points. In addition, mnemonic tables support popular microprocessors and communications formats.

Delta time provides greater speed and accuracy in measuring the time between selected events. After the cursors are positioned at two selected events on the timing diagram, the time difference can be read directly in the delta-time display field. The display indicates the appropriate time units, such as milliseconds, microseconds or nanoseconds.

The new mnemonic tables are available on DC-100 tape cartridges for the DAS 9100's optional tape drive and use the system's user-definable mnemonics capability. Mnemonics for the Z80, 1802, 6800, 6802 and 8085 are available, as well as communications formats for ASCII, EBCDIC and GPIB.

For data acquisition, three modules are currently available to meet specific design requirements. The 32-channel module provides 25MHz sampling, both synchronously and asynchronously, with 512 bits-per-channel memory and two clock qualifiers. The 8-channel module provides 100MHz sampling, both synchronously and asynchronously, with 512 bits-per-channel memory, separate acquisition and glitch memories, and one clock qualifier. The 4-channel module provides 330MHz sampling, both synchronously and asynchronously, with 2048 bits-

Because the human brain is equipped to process color information, color is a logical choice for encoding complex displays such as those found in logic analyzers.

Color comes to logic anal

per-channel memory. A special high-resolution mode provides 660MHz (1.5ns resolution) on two channels with 4096 bits-per-channel memory.

These modules can be intermixed to support a variety of applications. Up to 104 channels of data acquisition are available at 25MHz, up to 32 channels at 100MHz, up to 16 channels at 330MHz, and up to eight channels at 660MHz (1.5ns resolution).

A trigger arming mode allows high-speed data acquisition modules monitoring hardware activity to be triggered from slower-speed modules tracking software flow, with acquired data time-aligned in both timing and state table displays.

For pattern generation, there is a module with 16 data output channels at 25MHz, plus two independent programmable strobes. This can be extended to

48 or 80 channels of pattern generation with up to 10 programmable strobes by adding one or two 32-channel expander modules. The pattern generator also has several external control inputs, including branch on interrupt, that allow extensive interaction with the system under test.

Pattern generation can be used interactively with data acquisition—an asset during the early stages of digital hardware design before software becomes available. Test programs can be created using the pattern generator's powerful instruction set, which includes counting, looping and nested subroutines. These programs can then be used to stimulate the hardware circuitry while the data acquisition cards are used to capture the results.

The optional DC-100 magnetic tape drive allows the user to both

load and store all the system's set-up information, pattern generator programs and tests, reference memory data and mnemonic tables. The tape can provide for transfer of test and evaluation routines to production test personnel and service organizations.

The optional communications package consists of an RS-232-C port, GPIB interface and standard video out. The RS-232-C port and GPIB interface allow complete remote programmability of the DAS 9100 from a host computer or GPIB controller. Two DAS 9100s can also be operated remotely in a master-slave configuration.

The video out enables the user to obtain a hard copy of the contents of the CRT screen for records and documentation via a Tektronix 4612 or 4632 hard-copy unit.

ESL

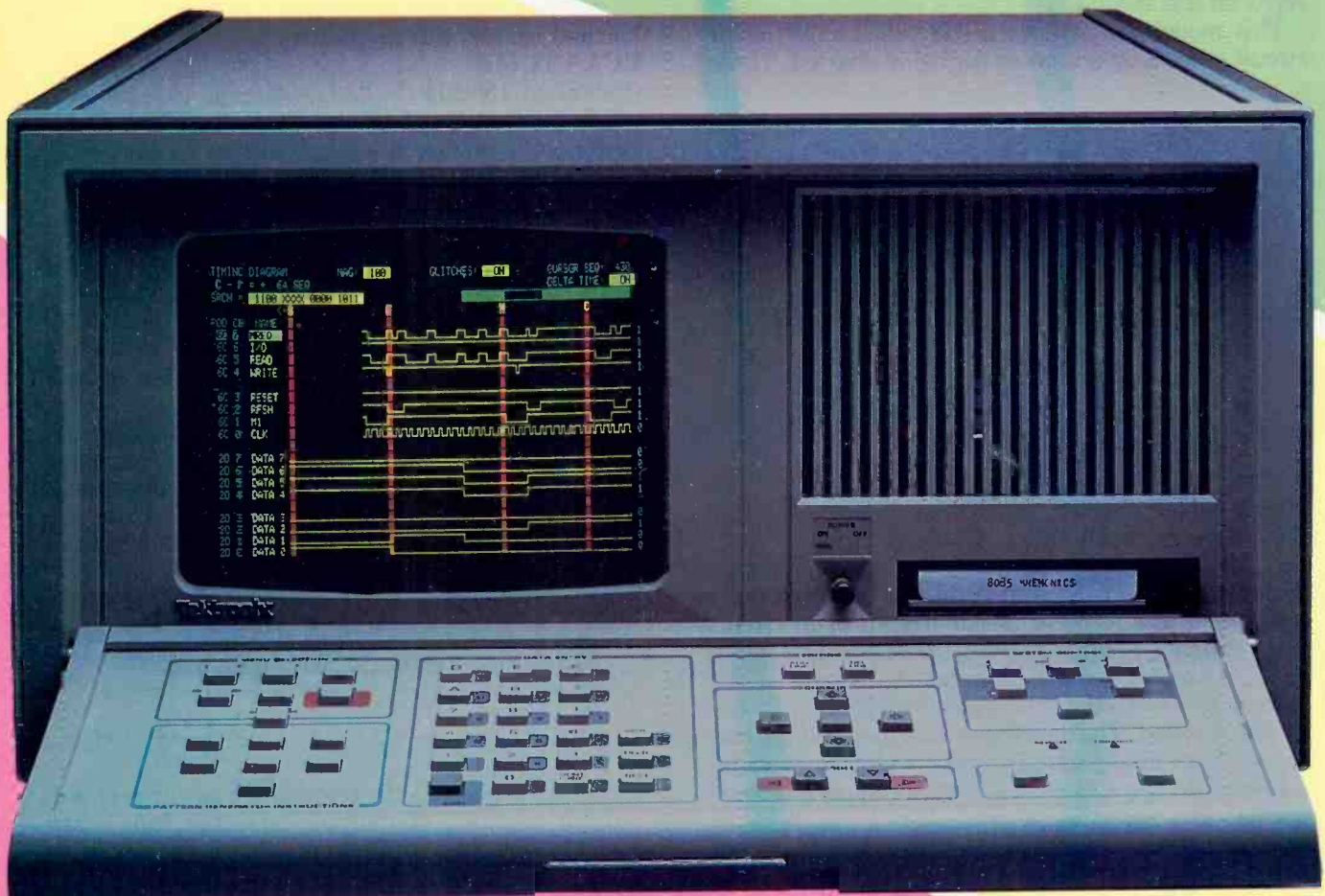

yzers

Troubleshooting Tips

Multiple defects RCA CTC52F (Photofact 1361-2)

The customer complained of difficulty in adjusting the channel selector to obtain a good picture. This appeared to be an easy job I could do in the customer's home, although the set was portable.

Cleaning and lubricating the tuner contacts allowed tuning in a good b&w picture on each active channel. Unfortunately, the receiver was a color set! When I asked the customer about the lack of color, she responded that she had been watching it that way for months. I asked if she wanted the color repaired and she did.

This model had several 6GH8 tubes in the color circuit, and these are noted for being shorted. Three

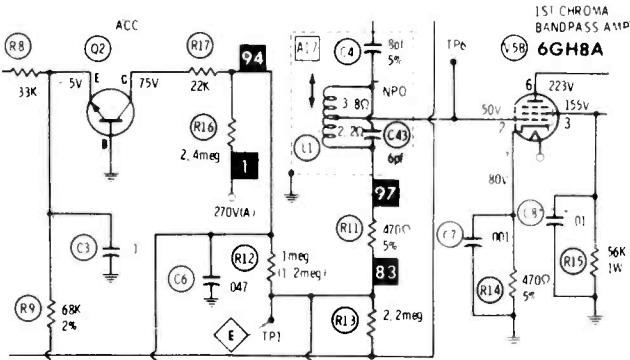

6GH8s tested shorted, but no color appeared after they were replaced. Next, I brought in my scope, and traced the color signal. A strong color signal was at the grid of the first-bandpass tube, but none was found at the plate. Evidently an open circuit was stopping plate current, because the plate voltage was higher than normal. As I wiggled the tube in its socket, the color flashed in. Evidently, the socket was bad. The distributor had just sold the last socket, but I finally found one at a technician's shop.

I installed the socket and the color appeared to be normal, but my triumph was short lived, because next day the customer called saying the color had quit. This time I decided to bring the television to the shop. When connected to an outside antenna or CATV cable, there was no color, but a color-bar generator produced strong color. The scope showed strong color at the first bandpass amplifier with all signal sources, but only the generator produced a signal at the plate. Quickly, I tested to make certain

the socket was not at fault again, but it was fine. Back at the schematic, I noticed that the automatic-chroma-control (ACC) and color-killer circuits connected to the V5B grid. When I grounded the ACC-killer test point (TP1), strong color was obtained for all signal sources. This pointed to a defect in the ACC or killer circuits, and indicated that the voltages and resistances there should be checked. There was no positive voltage at the Q2 ACC collector, and soon I found that R16 (2.4MΩ) was nearly open.

Installation of a new R16 restored color on all channels, but the tint control operation was not quite right, thus requiring a series of adjustments.

However, the receiver was stubborn, giving me one more problem. The next morning when the television was turned on, the color was bright, but without any luminance or b&w in the picture. This time the scope showed video at the delay line's input, but not at its output. After a new delay line was installed, the receiver again operated perfectly.

Phillip M. Jones, CET
Martinsville, VA

Normal raster, but no picture RCA CTC74F (Photofact 1568-1)

When first tested in our shop, the RCA had a raster with retrace lines but without a picture. A new set of replacement video modules gave no improvement.

I began checking power-supply dc voltages and soon noticed that the +252V source was about +30V; obviously causing the loss of video at the picture tube. I disconnected all loads from the +252V supply, but the voltage did not rise. When diode CR401 tested good, I began to suspect the flyback transformer.

Fortunately, before I wasted time replacing the flyback, I bridged the sections of filter capacitor C206, one section at a time, with a test capacitor. I was surprised after paralleling one section to see the picture appear. That section was open, but I had not

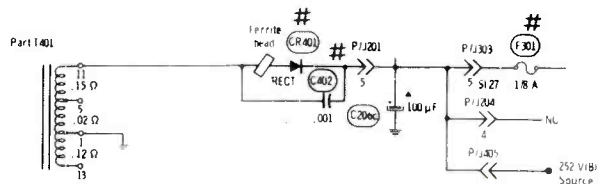

suspected it because the television was not very old. Other sections of multiple-capacitor cans often open shortly after the first one, so it is not advisable to add a single paralleling capacitor. Therefore, I obtained and installed an exact-replacement type, and there have been no callbacks.

Ron's TV
Valley Center, CA



Tek's most successful scope series ever: At \$1200-\$1450, it's easy to see why!

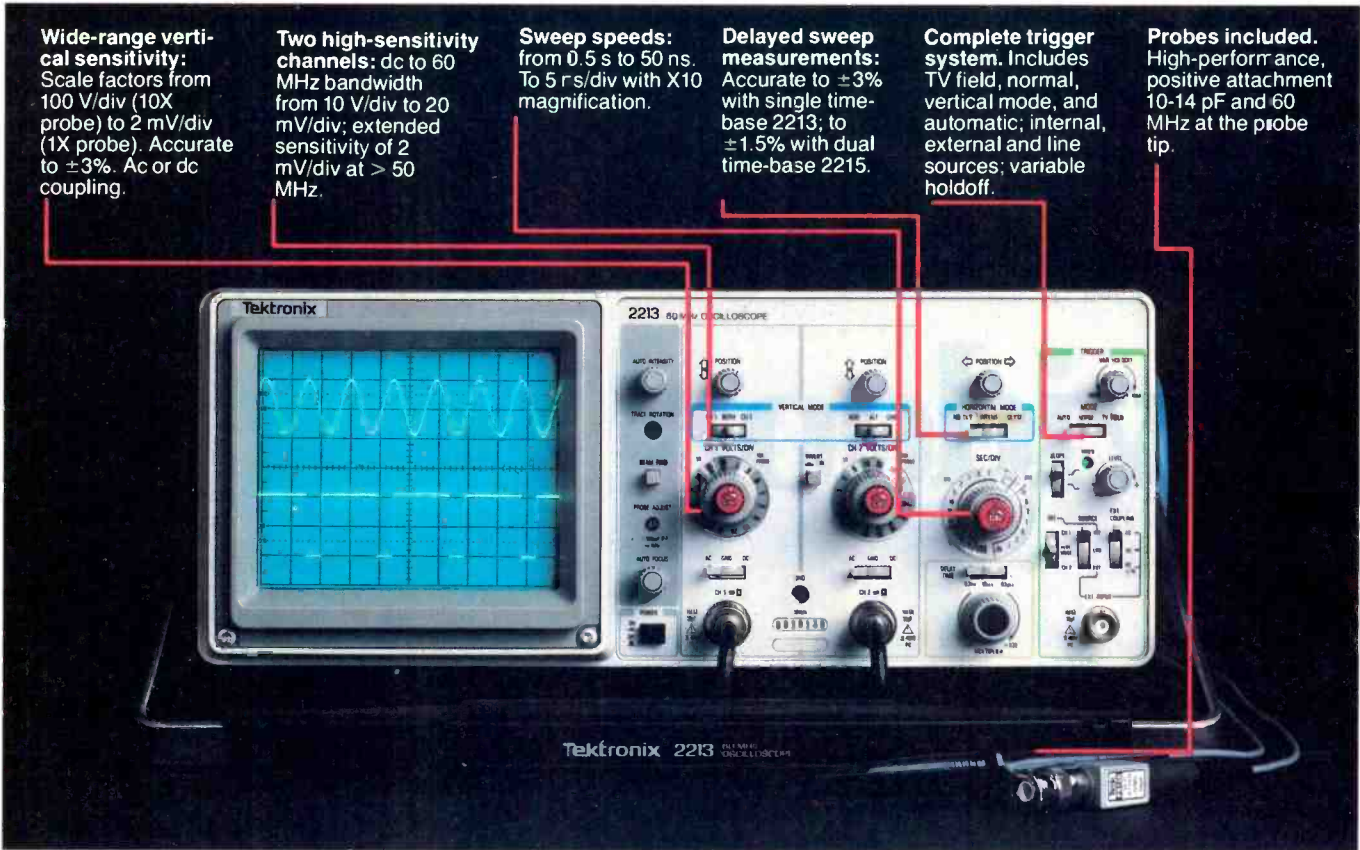

Wide-range vertical sensitivity: Scale factors from 100 V/div (10X probe) to 2 mV/div (1X probe). Accurate to $\pm 3\%$. Ac or dc coupling.

Two high-sensitivity channels: dc to 60 MHz bandwidth from 10 V/div to 20 mV/div; extended sensitivity of 2 mV/div at > 50 MHz.

Sweep speeds: from 0.5 s to 50 ns. To 5 ns/div with X10 magnification.

Delayed sweep measurements: Accurate to $\pm 3\%$ with single time-base 2213; to $\pm 1.5\%$ with dual time-base 2215.

Complete trigger system. Includes TV field, normal, vertical mode, and automatic; internal, external and line sources; variable holdoff.

Probes included. High-performance, positive attachment 10-14 pF and 60 MHz at the probe tip.

In 30 years of Tektronix oscilloscope leadership, no other scopes have recorded the immediate popular appeal of the Tek 2200 Series. The Tek 2213 and 2215 are unapproachable for the performance and reliability they offer at a surprisingly affordable price.

There's no compromise with Tektronix quality: The low cost is the result of a new design concept that cut mechanical parts by 65%. Cut cabling by 90%. Virtually eliminated board electrical connectors. And eliminated the need for a cooling fan.

Yet performance is written all over the front panels. There's the bandwidth for digital and analog circuits. The sensitivity for low signal measurements. The sweep speeds for fast logic families. And delayed sweep for fast, accurate timing measurements.

The cost: \$1200* for the 2213. \$1450* for the dual time base 2215.

You can order, or obtain more information, through the Tektronix National Marketing Center, where technical personnel can answer your questions and expedite delivery. Your direct order includes

probes, operating manuals, 15-day return policy and full Tektronix warranty.

For quantity purchases, please contact your local Tektronix sales representative.

**Order toll free:
1-800-426-2200
Extension 42**

In Oregon call collect:
(503) 627-9000 Ext. 42

*Price F.O.B. Beaverton, OR. Price subject to change.

Digital techniques in audio & video

By Carl A. Bentz

Personal computers or large business systems generally receive their input information from digital sources (e.g., keyboards, CRT terminals, punched cards, etc.). Industrial computers may be instructed by similar devices, but a computer used to control a manufacturing scheme (a process computer) may need to sense information from a non-digital source. For example, the position of a shaft turning within a machine, the temperature of a solution or the position of a hole to be drilled in sheet metal are analog values. They must be converted to digital information before the computer can process the information. Special circuits for sensing and control of analog phenomena by digital computers fall in the category of analog-to-digital and digital-to-analog devices, or A-D and D-A for short.

Applications of digital technology to audio and video require use of A-D and D-A converters. The analog signals are chopped into a myriad of pieces (digitized). This allows processing to be accomplished with the pieces by digital circuitry before reorganizing them back into typical analog signals. In order to chop the signals, a *sampling frequency* is needed. The sampling frequency is generated by the sampling clock (which will be related to the clocking frequency of the associated digital equipment). A sampling system uses a square wave control signal on one input to a gating circuit. When the control signal is high (logic 1), the analog signal is applied to a digitizing device. Between samples, the control is low (logic 0), blocking the input information. An AND gate could also be used for such a sampling

circuit.

The signal level of each digital sample is maintained momentarily by a storage system (often a capacitor). The stored signal is applied to a resistive ladder arrangement. Taps into that resistive ladder each offer a voltage level that will depend upon the overall signal. Each tap point is compared to a reference level, and if the tap presents a higher level, the comparator circuit output is high (1). If the tap level is low, the comparator yields a low (0) output. The number of taps will determine the resolution of the signal level (i.e., the more taps, the more accurate the combination of 1s and 0s will represent the original signal). The number of taps in the A-D circuit will determine the number of *quantizing bits* being used in the system.

Also, for signal fidelity, the

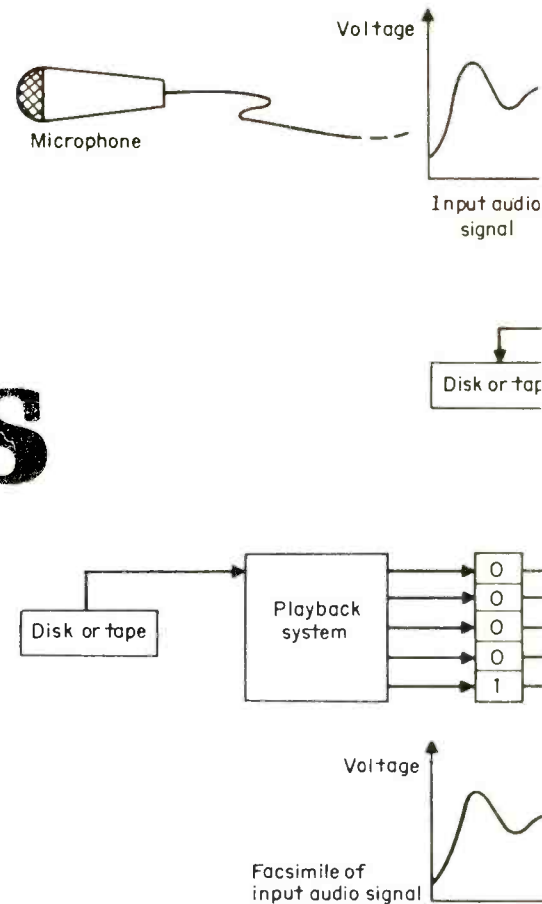

The basic electronic system components for encoding and decoding digital audio signals for (a) recording system and (b) playback system. (From the Electronic Engineers' Handbook by Donald G. Fink and Donald Christiansen. Copyright (c) 1982 by McGraw-Hill. Used with the permission of McGraw-Hill Book Company.)

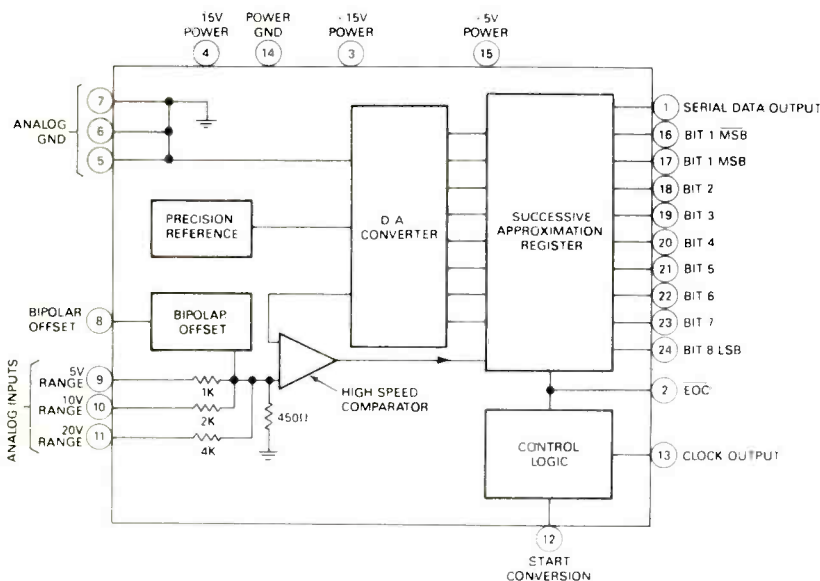
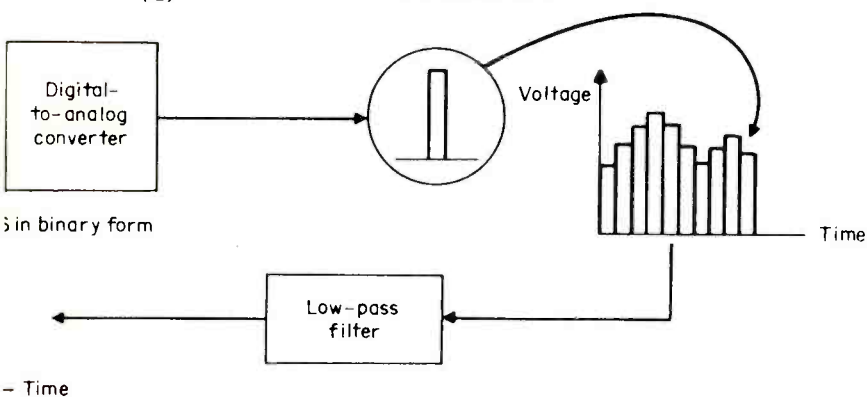
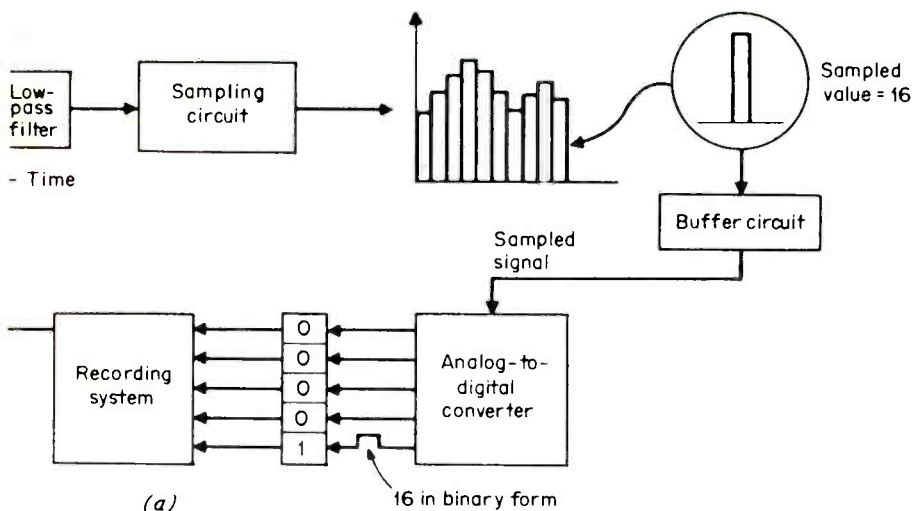

One type of analog-to-digital converter features a D/A converter and successive approximation register to convert analog signals into their digital equivalents. (Block diagram courtesy of Datel-Intersil, Mansfield, MA)

sampling frequency will be of great importance. The *sample rate* must be high. In fact, the higher the rate at which sampling is done, the more accurately the digitized signal will represent the waveform of the original material. Sampling rates must be at least twice the highest frequency information in

the signal if no information is to be lost in sampling. For the new digital audio equipment, a world standard has been generally agreed upon at 48kHz for professional-grade equipment. In other words, the sound is chopped into 48,000 pieces per second, and the amplitude of each piece resolved

into 16 different levels (bits). Because the samples are taken at a rate of one per about every 12 μ s, it is not likely that information from the audio signals will be lost. Human hearing is generally limited to 18kHz, with equipment built to deal with frequencies to 20kHz to make certain that harmonics are included in the final product.

The video standard generally in use is 13.5MHz, or one sample taken every 0.074 μ s (or about 858 samples per video line). Television studio equipment is often rated to function to 8MHz, with the home receivers very limited to 4.5MHz and less. Thus, a very definite amount of *overhead* is provided to preserve fidelity. In the video samples, varying quantizing bit levels are used (8, 9 and 10 per sample) but most equipment is using an 8-bit scheme. In other words, the video voltage for a given spot on the screen (1/858 of a line) is converted to a digital number consisting of 8 bits. In addition, luminance and chroma are often separated prior to the sampling and bit-slicing techniques to offer even greater accuracy in the processes.

Let us stop for a moment and consider what the 8-bit and 16-bit quantizing means. Digital concepts are based on arithmetic, based on the number 2. One bit allows us to have either 0 or 1. Two bits will allow four combinations (00, 01, 10, 11); eight bits will provide 256 individual signal levels to be sensed for the video; 16 bits will divide the audio into 65536 levels.

Once the signals are converted into the digital numbers, they may be mixed through AND gates, OR gates and INVERTER circuits. Entire samples may be moved around in time, repeated or deleted to achieve whatever effects might be desired. A few minutes of watching a newscast, where pictures slide off the screen behind the news reporter, pictures appear as if one were turning pages in a book or pictures are run through a "mix-master" and then reorganized into a real image, offer some of the possibilities that are being done with digital video. Additionally, when pictures are revolved about the horizontal (x), vertical (y) or center (z) axes of the screen, you can be assured that

digital processing is involved.

Once the effects and processing are completed, the A-D circuits are used to convert the mass of digital information back into an analog signal. Because the sampling rate employed is so high, little filtering will be needed to smooth the signal transitions or discontinuities (the instantaneous changes from one sample to another). Components for these filters will resemble those of a power-supply filter in concept, but the component values will be very small (perhaps at times a short length of wire will be an inductor and the distance between two foil paths on the circuit board will be the capacitor).

So how does all this affect the listener or the viewer? What difference will it make to the technician who wants to keep equipment operating? At present, all of the digital processing for both audio and video is being done before the information is put onto a normal phono disc, recorded onto the consumer 1/2- or 3/4-inch tape or even transmitted via the airwaves to the radio and TV sets in analog form. All home listening and view-

ing equipment is analog in nature—but not for long.

The systems currently under consideration are still being worked out. Of the several disc systems being marketed, just like BETA and VHS videotape, discs for one are incompatible with those for another. The same thing could occur for digital audio recordings. While the concepts involved in recording and playback will be the same, the total processes will differ, rendering them incompatible. The result will be confusion for the consumer, rather than improved materials.

The reason digital processes will be important to the consumer is because they will allow multiple generations (re-recordings) to be made without any loss from the original material. Pictures and sound will be based upon the resolution provided by the number of bits in the samples. Noise levels (instantaneous changes in level introduced by the re-recording process, generally of a non-related frequency to the desired material) are avoided, because the reproduced digital signal level is strictly

controlled by the bits in the sample. Distortion is avoided because of the same signal quality control. Phase relationships are also encoded into the digital values and problems inherent in analog recording are solved. What we hear will be what was originally recorded, within the properly operating capabilities of our listening/viewing devices. Those available today lack most of those capabilities. Many maintenance methods used today will not suffice in the soon-to-be-introduced digital consumer devices.

Those with some knowledge of logic circuitry should brush up on how it works. Those without logic experience need to check into the basics, get a good foundation in the techniques and expand themselves by tinkering with the relatively simple IC logic circuitry available from the local electronics shop. Even if the digital audio and video equipment doesn't show up next week, there are always home computers and digital-based TV games to service.

ES&T_m

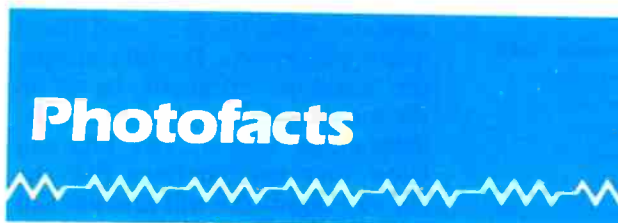

These Photofacts for TV receivers have been released by Howard W. Sams & Company since the last report in ES&T.

BOHSEI

BR-5520B, TR-005B 2118-1

HITACHI

CT19Y3/9Y7/923/927,H 2130-1

JC PENNEY

685-2042G,-20, 685-2044G,-00 2117-1
 685-2045G,-00/051G,-00/063G,-00 2119-1
 685-2032A,-20 2127-1

KMC

KMB-1230G 2128-1

MGA

CK-2582 2120-1

PANASONIC

TR-5091P 2118-2

QUASAR

Chassis ANSE/ASNE/SNE/YASN/DTS-976 2118-3

Chassis TS-993 2126-1
 Chassis NDTs-979 2129-1
 Chassis APDTS/YAPDTS-979 2130-2

RCA

Chassis KCS204CA,CC,CJ (1983 Prod.) 2120-2
 Chassis KCS207A,B, Radio RC3040/41 2122-1
 Chassis CTC121A,B 2123-1
 Chassis KCS205CA (1983 Prod.) 2124-1
 Chassis CTC120A 2125-1
 Chassis CTC111L,N,R 2126-2
 Audio Module 2126-2-A
 Chassis KCS204BC,BK (1983 Prod.) 2127-2

SHARP

13G23/25 2121-1
 13G27 2122-2
 19G77 2123-2
 3K-91 2125-2

SONY

Chassis SCC-625T-A,U-A 2117-2
 Chassis SCC-406E-A,F-A 2124-2
 Chassis SCC-406C-A/420B-A 2128-2

WARDS

Chassis M32-70/71 2121-2
 GGV12993A,B,C 2129-2

ZENITH

Chassis 12NB4X 2119-2
 Chassis 9KB4X 2121-3

ES&T_m

Part for part, more turn-ons than ever before.

The new ECG Master Guide is here with even more Sylvania semiconductors.

It's called the Master because it's far and away the industry's most comprehensive source for getting the parts you need, when you need them. In its 500+ pages, you'll find over 200,000 original parts which can be cross-referenced to 3000+ replacement products. Since the last Master, those replacements include more than 700 new types, and most hard-to-find foreign parts.

Replace your old guide with the new, bigger and better Master today. It's as easy as calling 1-800-225-8326 toll-free (in Massachusetts, call 1-617-890-6107) for the name and number of your nearest distributor. Or just send \$3.25 to: Philips ECG, Inc., 70 Empire Drive, West Seneca, New York 14224.



**If it's ECG, it fits.
And it works.**

Philips ECG

A North American Philips Company

Methods of equalizing tape recordings

By Carl Babcoke, CET

Frequency equalization is an essential part of the recording and playing of magnetic tapes. Circuits using capacitors and resistors that increase or decrease the frequency response at specific frequencies are described here.

Flat frequency response over the entire audio bandwidth from about 32Hz to 16,000Hz is considered to be essential for good sound reproduction. At least that is desired response for radio and TV broadcasting and many other audio applications.

However, not all links in the electronic and acoustic chain have flat frequency response. Amplifiers are the easiest to design for flat response, so many are rated at ± 1 dB or better from 20Hz to 20kHz (which exceeds the hearing ranges of most people).

Other items of equipment have frequency responses that are far from flat, and these must be corrected by a process called *equalization*.

Definitions

A simultaneous increase or decrease of all audio frequencies is called a volume change, a level adjustment or (electrically) an

amplitude change.

An amplitude adjustment to specific bands of adjacent frequencies is called equalization. This can be as simple as the treble tone control found on many radios. Rotation of the tone control decreases the amplitude of all higher audio frequencies.

A telephone line between a radio remote location and a radio studio has flat response only for a few hundred feet. For longer distances, attenuation of high audio frequencies occurs, so a variable equalizer is used at the radio control room. One type of line equalizer introduces an adjustable loss to all frequencies except the one that needs increased amplitude. Compromise adjustments of resonance frequency and loss can produce a fairly flat response.

Some music sources are inherently non-flat and must have extensive equalization to achieve flat frequency response. Magnetic tape is in this category. Other sources have pre-equalization and post-equalization (to provide improved signal-to-noise ratio) while giving overall flat response. Examples are phonograph records and FM-radio reception. Equalization is vital for obtaining flat response from cassette tapes.

Magnetic head response

All cassette tapes must be recorded by a magnetic head (this is also true for commercial music tapes duplicated at high speeds)

and played by the same or another complementary-type playback magnetic head, as explained in the July 1982, **Electronic Servicing & Technology** article "The basics of tape recording." Magnetic recording heads derive their signals primarily from current, so a current that is the same for all audio frequencies (constant current) provides a flat recorded response on the tape.

The first problem arises when a magnetic playback head receives the flat-recorded energy from a tape track. As shown in Figure 1, the response increases from a low value at low frequencies (called *bass* in music) to a maximum at a certain frequency (determined by tape speed and gap width). Then increasing the frequency above this maximum point reduces the amplitude rapidly to a null at one wavelength. If the graph is extended, additional and weaker maximums followed by nulls are discovered. The explanation has to do with the magnetic cycles versus the gap width of the playback head, as shown in Figure 1.

Faster tape speeds and narrower playback-head gaps raise the frequency where the maximum response point occurs. With cassette audio tapes, the speed is fixed by industry agreement at $1\frac{7}{8}$ inches per second. Therefore, the playback-head gap is the only basic that can be changed to extend the high-frequency response without adding additional equalization in the amplifier.

“When will someone introduce high-performance scopes without the high prices?”

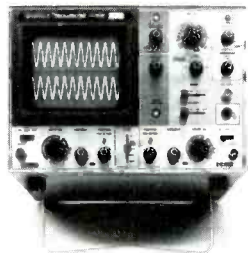

V-152F — 15 MHz

\$595

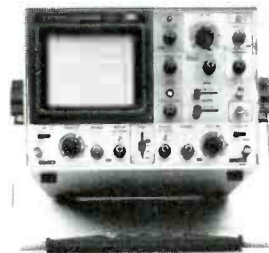

V-202F — 20 MHz

\$695

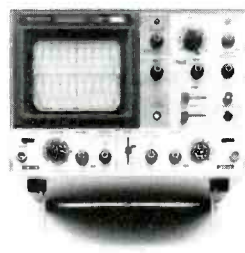

V-302F — 30 MHz

\$799

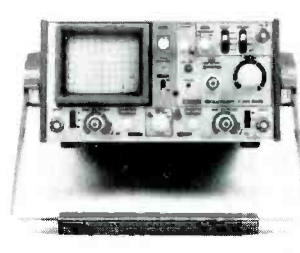

V-209 — 20 MHz

\$945



V-353F — 35 MHz

\$949

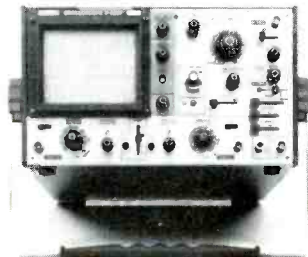

V-650F — 60 MHz

\$1,195

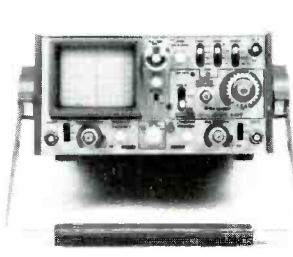

V-509 — 50 MHz

\$1,650

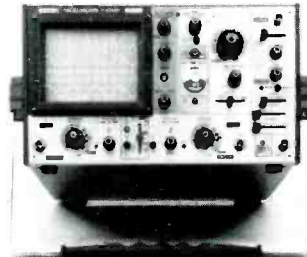

V-1050F — 100 MHz

\$1,980

HITACHI HEARD YOU.

Ask no longer. Hitachi has just answered your question with 8 new portable oscilloscopes. In fact, they're the highest-quality scopes around for the money.

We call them our F series. They range from 15 MHz to 100 MHz and can be used for all types of bench and field work. There are dual-trace and quad-trace models. Several have delayed sweep. All are lightweight. Compact. And feature functionally grouped operating controls and bright, easy-to-read CRTs. Here's a closer look at each model:

V-152F. A 15 MHz, dual-trace scope, sensitive to 1 mV/div at 7 MHz. It has a 5" CRT. **\$595.**

V-202F. A 20 MHz, dual-trace scope, sensitive to 1 mV/div at 7 MHz. It has a 5.5" CRT. **\$695.**

V-302F. A 30 MHz dual-trace scope, sensitive to 1 mV/div at 7 MHz. It features signal delay and a 5" CRT. **\$799.**

V-353F. A 35 MHz, dual-trace delayed sweep scope, sensitive to 1 mV/div at 7 MHz. It features a 5.5" square CRT. **\$949.**

V-209. A 20 MHz, dual trace, mini-portable scope, sensitive to 1 mV/div at 5 MHz. It features AC/DC operation and has a 3.5" CRT, and weighs only 10 lbs. Battery included. **\$945.**

V-650F. A 60 MHz, dual-trace scope, sensitive to 1 mV/div at 10 MHz. It features delayed sweep and a 6" CRT. **\$1,195.**

V-509. A 50 MHz, dual-trace, mini-portable scope with optional battery pack, sensitive to 1 mV/div at 10 MHz. It features delayed sweep and a 6" CRT, and weighs 11 lbs. **\$1,650.**

V-1050F. A 100 MHz, quad-trace scope, sensitive to 0.5 mV/div at 5 MHz. It features delayed sweep and a 6" CRT. **\$1,980.**

There they are. High-performance scopes without the high prices. And all are backed by Hitachi's reputation for quality. To learn more, write or call us today. Hitachi Denshi America, Ltd., 175 Crossways Park West, Woodbury, NY 11797. Phone: (516) 921-7200. Offices also in Atlanta, Chicago and Los Angeles.

Circle (7) on Reply Card

Recording and playing equalization

Because the constant-current recording can theoretically produce a flat recording on the tape, it seems reasonable that a 6dB-per-octave low-frequency boost in the playback amplifier would correct the playing response, giving overall flat response. To a large extent, this is true (Figure 2), but there are other high-frequency losses in the system.

Increasing the high-frequency gain in the playback amplifier would intensify the tape noise as it corrected the HF response. That is not desirable, because cassette noise is now almost excessive under ideal conditions.

A solution is found in the distribution of power at various frequencies of music. Reproduction of the sounds of organs, bass viols and bass guitars requires most power below 100Hz, while the sounds of cymbals and drum sticks struck together are short-duration noise pulses that require much power at extreme high frequencies. But these are exceptions,

because maximum power for orchestras or musical groups is needed at lower medium frequencies. Therefore, it becomes desirable and possible to add considerable treble increase (usually called treble boost) to the recording amplifier (Figure 3) without producing serious amplifier or head overloads.

Although industry-standard recording and playing curves are shown in Figures 3 and 4, only the playing curve is ever tested separately. When the playing curve gives flat response from a special test tape, the recording curve is designed by the manufacturer to produce an overall flat response after recording and playing in that one model.

Producing equalizing curves

Equalizing curves in most cassette machines are made from high-pass and low-pass filters. Therefore, these filters must be understood first.

Figure 4 shows schematics of high-pass and low-pass filters with values given for the resistors and

capacitors. Both filters provide the same 1000Hz turnover point. The turnover point of a filter produces -3dB at the frequency where the resistor's resistance and the capacitor's reactance (both expressed in ohms) are equal to each other.

Turnover-frequency points and the changes they give from flat audio response are determined by the filter's time constant. Stated simply, time constant is the length of time required to charge a capacitor (through a resistor) to 63.2% of the supply voltage. Conversely, it is the time required to discharge a capacitor through a resistor to 36.8% of the original capacitor voltage.

For calculations, the time constant in seconds equals the capacitance in farads multiplied by the resistance in ohms, but those are not appropriate terms for audio. Time constant in seconds equals the capacitance in microfarads times the resistance in megohms. A more useful variation is *time constant in microseconds equals the*

Theoretical playback response

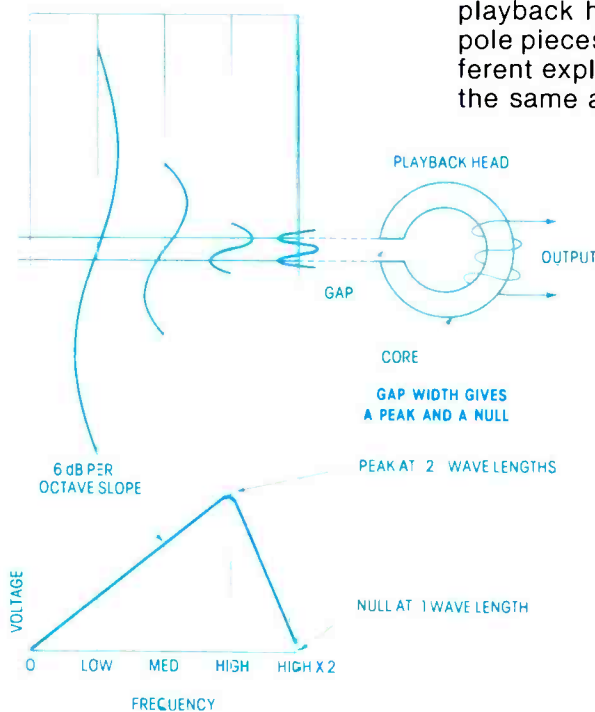

Figure 1. Output amplitude from any inductance depends on the magnitude of the magnetic flux and how rapidly it is changing. A playback head is an inductance, but it is a special case with the pole pieces facing each other across a narrow gap. Therefore, a different explanation can make the operation more clear. If the flux is the same at both gap edges, the head output is zero. If the flux is positive at one gap edge and negative at the other, the perceived flux is maximum and the head output is maximum. This drawing shows the head-output signal at four sinewave frequencies. At low frequencies, the gap edges have opposite polarity, but the gap is across very little of one cycle (rate of change is small), so the signal amplitude is weak. At medium frequencies, the conditions are the same, but a larger percentage of the cycle is between the gap edges, giving a stronger output signal. When the tape speed and signal frequency produce a two-wavelength cycle at the head gap, maximum output is obtained because full flux is between the gap edges. Frequencies higher than two wavelengths have the same flux polarity at both gap edges, but one is stronger than the other. They partially cancel, giving weak output. Finally, when the signal has one-wavelength across the head gap, the head output is zero, because the phase of flux is the same, and the head senses this as zero signal. These conditions apply to all audio playback heads, although faster tape speeds and narrower head gaps raise the maximum and cancellation frequencies.

LOW COST EDUCATION IN A VHS CASSETTE



VIDEO TRAINING TAPES – AVAILABLE IN VHS FORMAT ONLY

INDUSTRIAL VIDEO

NV-4500 (1 Tape)	\$50.00
NV-9600 (2 Tapes)	\$65.00
NV-8050 (1 Tape)	\$50.00
NV-8350 (1 Tape)	\$50.00
NV-8950 (1 Tape)	\$50.00
NV-8500 (2 Tapes)	\$65.00
NV-8420 (1 Tape)	\$50.00

CONSUMER VIDEO

PV-1770 (2 Tapes)	\$65.00
PV-5000 (1 Tape)	\$50.00
PV-1780 (1 Tape)	\$50.00
PV-1480 (1 Tape)	\$50.00
PV-1265 (1 Tape)	\$50.00
PV-1310 (2 Tapes)	\$65.00

COLOR CAMERA

PK-751 (1 Tape)	\$50.00
PK-756 (1 Tape)	\$50.00
PK-802 (1 Tape)	\$50.00
PK-956 (1 Tape)	\$50.00
PK-972 (1 Tape)	\$50.00

The above tapes are "Alignment Tapes" and cover both electrical-mechanical adjustment procedures as well as unit disassembly. They can be used in conjunction with their respective Service Manuals, which are available through your local Panasonic Parts Distributor.

NV-9600 Basic Descriptions

– Describes the Micro-processor based system control sections.

(1 Tape) \$50.00

PV-1650 Introduction & Circuit Description

– Explanation of special effects, 4-heads used

(1 Tape) \$50.00

PK-200/300 Simplified Vidicon Replacement

– Demonstrates the method to use when the vidicon is the only problem.

(1 Tape) \$50.00

AUDIO TRAINING TAPES – AVAILABLE IN VHS FORMAT ONLY

RS-M280/RS-M258R – Record/Playback Head Adjustment Series	(1 Tape)	\$50.00
Cassette Troubleshooting/Electrical Circuits	(1 Tape)	\$50.00

TRAINING MANUALS

VHS SERVICE BULLETIN REFERENCE MANUAL	1st ISSUE	\$ 2.50
VHS SERVICE BULLETIN REFERENCE MANUAL	2nd ISSUE	\$10.00
VHS SERVICE BULLETIN REFERENCE MANUAL	3rd ISSUE	\$10.00
INDUSTRIAL VIDEO SERVICE BULLETIN REFERENCE MANUAL	1st ISSUE	\$30.00
INDUSTRIAL VIDEO SERVICE BULLETIN REFERENCE MANUAL	2nd ISSUE	\$20.00
PK-700/750/800 SERVICE HINTS		\$14.95
PV-1265 SERVICE HINTS		\$14.95
PV-5000 SERVICE HINTS		\$14.95
A PRACTICAL DIGITAL TROUBLESHOOTING GUIDE		\$15.00
TELEVISION TROUBLESHOOTING TIPS	1st ISSUE	\$14.95
TELEVISION TROUBLESHOOTING TIPS	2nd ISSUE	\$20.00
AUDIO CASSETTE TROUBLESHOOTING GUIDE		\$20.00

Enclose with order check or money order payable to "Engineering Support Division" and mail to: Matsushita Engineering and Service Company (MESCO), ESD/Publications Department, 50 Meadowland Parkway, Secaucus, NJ 07094. For further info: (201) 348-7191.

capacitance in microfarads multiplied by the resistance in ohms. The formula can be written:

$$TC (\mu s) = C (\mu F) \times R (\text{ohms})$$

Time constants can be changed to turnover frequencies, and turnover frequencies can be changed easily to time constants. There are two basic formulas used for audio designs:

$$TC (\mu s) = 159,155 \div F (\text{Hz})$$

$$F (\text{Hz}) = 159,155 \div TC (\mu s)$$

Understanding of these formulas and definitions can make

clear the equalizations used in cassette machines and the technical ratings of tapes.

Bass-boost filter

A simple low-frequency-increase (bass-boost) circuit is shown in Figure 5, with an actual frequency-response graph of the circuit operation. The values are compatible with transistor circuits that require lower resistor values and larger value capacitors than those formerly used for tube circuits.

The circuit is a voltage divider with an attenuation that varies

with frequency. The top leg of the voltage divider is R1, while the bottom leg is the sum of R2 plus C1. Those values were chosen to provide optimum bass boost (+5dB at 200Hz, +10dB at 100Hz, and +14dB to +15dB at 50Hz), without excessive attenuation of middle and high frequencies.

At treble high frequencies, C1 is virtually a short circuit, so the treble attenuation is determined by the voltage-divider ratio of R1 + R2 to R2. In this case, the ratio is about 10:1 (20dB) for all frequencies above 1000Hz. As the frequency is reduced gradually below 1000Hz, the reactance of C1 increases, thus raising the total impedance of the bottom leg (R2 plus C1), which decreases the attenuation (giving the illusion of increased gain). At extremely low frequencies, the reactance of C1 approaches 100KΩ, reducing the voltage-divider attenuation to almost zero and giving the illusion of maximum bass boost. Because a reduction of attenuation provides relative bass boost, it becomes clear that the bass boost never can exceed the HF attenuation. The attenuation loss is the price paid for this equalization.

This circuit operates by turnover and time-constant theory. C1 (0.1μF) and R2 (5600Ω) are the two components making up the bass-boost time constant. Therefore, the turnover time constant is 560μS, and that calls for +3dB at about 285Hz, while the graph ap-

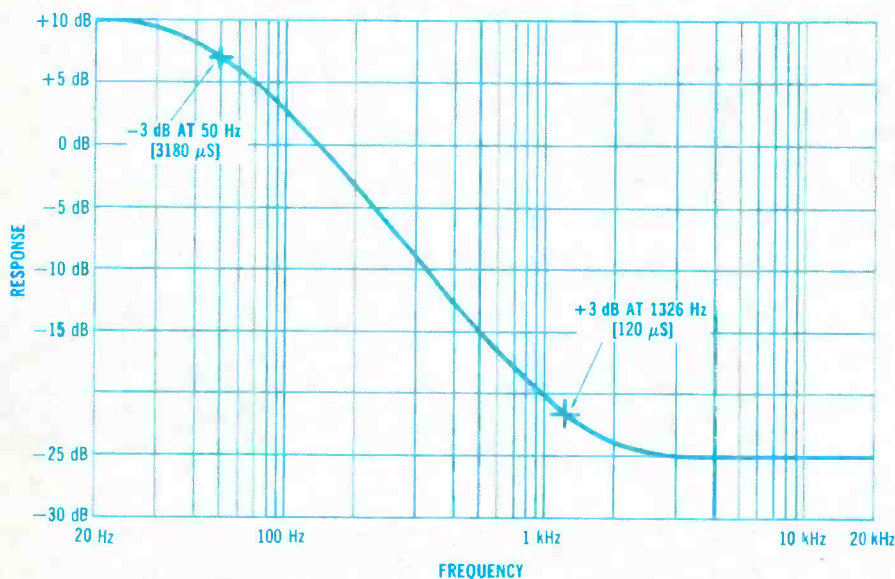

Figure 2. The industry standard playback response (for 120μs-recorded cassettes) has large bass boost with an upper 1326Hz turnover (+3dB). A second turnover with -3dB from maximum gain is at 50Hz.

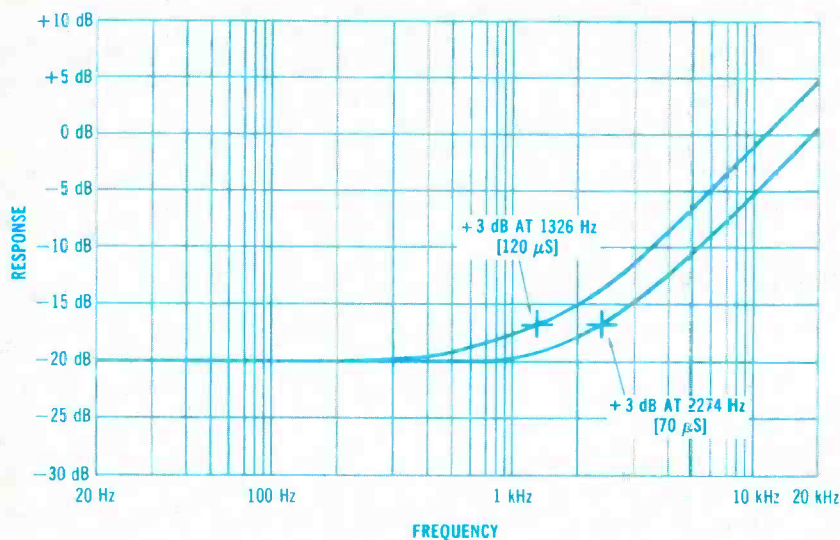
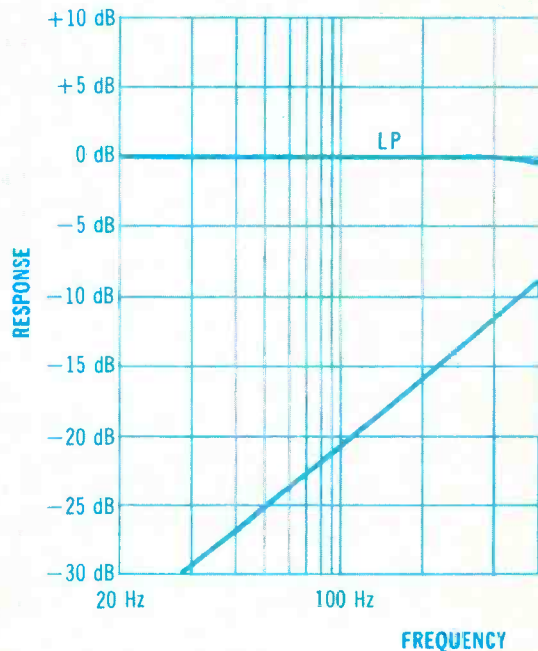

Figure 3. Pre-emphasis equalization during recording varies according to tape types. The +3dB turnover frequency is 1326Hz for normal-bias 120μs cassette recordings, while 70μs and 2274Hz are used for chromium-dioxide higher-bias tapes.



pears to reach +3dB at about 250Hz. That is good agreement between theory and an actual circuit, because the components had .20% tolerances.

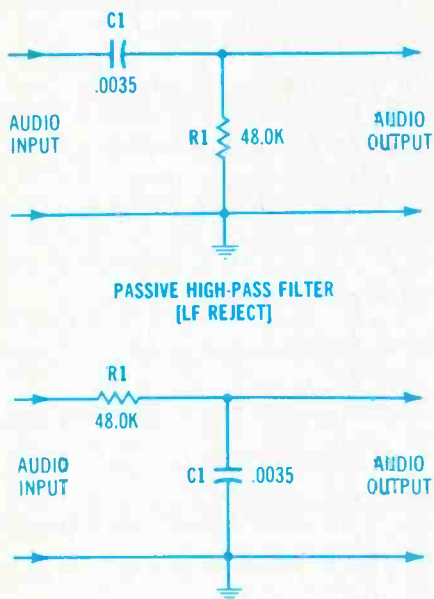
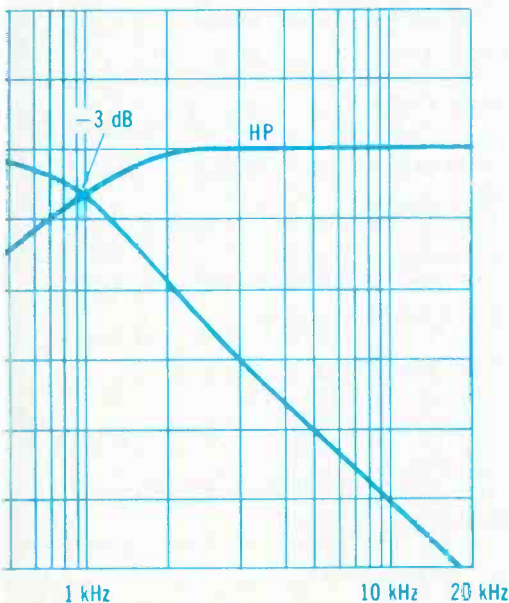

Figure 4. High-pass and low-pass passive filters constructed from identical resistance and capacitance values provide turnover at the same frequency. (A) These values in a simple high-pass filter gave a -3dB response at 1000Hz. (B) The same components arranged in a low-pass filter gave the same -3dB response at 1000Hz. On the graph, the response of the low-pass filter has flat 0dB response at the left, while the high-pass filter has flat response on the graph's right. Responses from simple filters never can exceed 6dB-per-octave, while many achieve only about 5dB-per-octave in the audio band.



Simpson®

Lets you
select from 12
Safety Listed DMMs



Only Simpson offers a full line of DMMs that are listed under UL-1244 Standard for Safety — Electrical and Electronic Measuring and Testing Equipment.

SIMPSON DIGITAL MULTIMETER SELECTION CHART

Model	Hand portable DMMs All 2x5.6x4.6", weight 1½ lbs.					Bench portable DMMs All 2.7x8.4x9", weight 3 lbs.		
	467/467B#	463	461-2	461-2R	462	464-2A/2D*	465-2A/2D*	460-4A/4D*
Features	Deluxe unit with true RMS, pulse detection, differential peak hold, visual/audible continuity indication. #Black case	Basic low cost cordless unit	Low cost basic unit	True RMS responding	Auto and manual ranging	Low cost bench DMM with 10 amp range	Auto and manual ranging, 10 amp range	Deluxe unit. Low power ohms, aux. analog meter, 10 amp range
Ranges	26	26	26	26	23	28	27	32
Display (3½ digit)	LCD Digalog® display	LCD	LED	LED	LED	LED	LED	LED
Basic Accuracy	0.1%	0.1%	0.1%	0.1%	0.25%	0.1%	0.1%	0.1%
Power Source	9 V battery supplied, 200-hour battery life		Rechargeable batteries and AC adapter/charger supplied			AC operation standard. *AC/battery version optional (batteries not included)		
Price	\$257	\$200	\$194	\$234	\$244	\$290/*\$338	\$403/*\$453	\$378/*\$431

Choose the one that's best for you! Available at leading electrical/electronics distributors worldwide.



SIMPSON ELECTRIC COMPANY
A Katy Industries Subsidiary

853 Dundee Avenue, Elgin, IL 60120
(312) 697-2260 • Telex 72-2416 • Cable SIMELCO
IN CANADA: Bach-Simpson Ltd., London, Ontario
IN ENGLAND: Bach-Simpson (U.K.) Ltd., Wadebridge, Cornwall

Circle (9) on Reply Card

January 1983 *Electronic Servicing & Technology* 21

Suggestions for boost filters

For anyone who might want to modify the previous bass-boost circuit, here are suggestions to make the project successful.

- Notice on the Figure 5 graph that the amount of bass increase began to weaken at the extreme low frequencies. As explained, the roll-off is caused by approaching too near the point of minimum attenuation, where the increasing reactance of C1 cannot vary the output in step. In other words, if the reactance of C1 changes from 10,000Ω to 20,000Ω in one octave (half frequency) the sum of C1 + R2 changes from 15,600Ω to 25,600Ω giving about +5dB change. A change of C1 from 50KΩ to 100KΩ in a lower octave changes the C1/R2 sum from 55,600Ω to 105,600Ω, but the output changes very little because both sums are larger than R1, the

voltage divider's top leg. Therefore, if increased bass boost with steeper curve is desired below 100Hz, additional high-frequency attenuation must be provided by an increase in the value of R1, perhaps to 100KΩ.

- The driver of the boost circuit and the following amplifier must be compatible with the boost circuit, and the driver of the boost circuit should have low impedance. Notice that the total impedance of the circuit changes with frequency, so the output amplitude and frequency response of a high-impedance driver will vary as the boost-circuit resistance changes. Even more important, the input impedance of the amplifier stage following the boost circuit must be high (perhaps an emitter follower). To provide bass boost, the R2/C1 impedance must change, and an unvarying low-resistance load across those components would reduce or perhaps eliminate any boost. Of course, the R2 and C1 values could be changed to 1,500Ω and 0.25μF, which would minimize the loading problem.

- Also, the circuit can be modified into a loudness control (that gives bass boost at soft volumes) by adding R2 and C1 in series between the tap of a 100KΩ audio volume control and ground. With controls designed for the circuit, the transition between boost and flat is not

very noticeable, and there is no loss of gain when the control is turned above the tap.

Treble-boost filter

For the previous bass-boost circuit, the principle was to attenuate all frequencies and then remove the attenuation for whatever frequencies are to be increased. The same action can be used to provide high-frequency increase (treble boost). As shown in the Figure 6A circuit, R1 and R2 are the voltage-divider resistors, giving almost a 20dB (or 10-to-1) loss.

A capacitor of appropriate size is connected across R1. This capacitor is between the input and output points, so it removes the loss at high frequencies. The Figure 6C graph shows the resulting frequency response. Actually, the C1 value is too large (bringing the boost far down into the middle frequencies) for use as an audio high-frequency boost circuit. But it was chosen to show the rounding of the curve at each end. Usually, a curve will be placed on the graph so only one flattened end is shown.

Only near the curve's center can the response change with the approximate theoretical figure of 6dB (half or double voltage) per octave (half or double frequency).

Both the top and bottom curve ends flatten, giving very little gain change per octave, but the reasons are quite different. At the high-frequency end, the curve runs out of steam when it approaches the end of minimum attenuation. At higher frequencies, where C1 is a virtual short circuit, no increase of response is possible. At the low-frequency end, the reactive impedance of C1 becomes so high, compared to R1's resistance, that the voltage divider ratio is changed very little. Therefore, the low frequencies have the predicted 19+dBs loss from the R1/R2 voltage-divider ratio.

There is one possible problem with the Figure 6A circuit: The driving circuit might be overloaded or suffer a loss of high-frequency output. At high frequencies where the C1 reactance is nearly a short circuit, the filter load on the circuit that drives it would be 5600Ω (R2), rather than the expected 53.6KΩ from R1 and R2 in series. The effect at high fre-

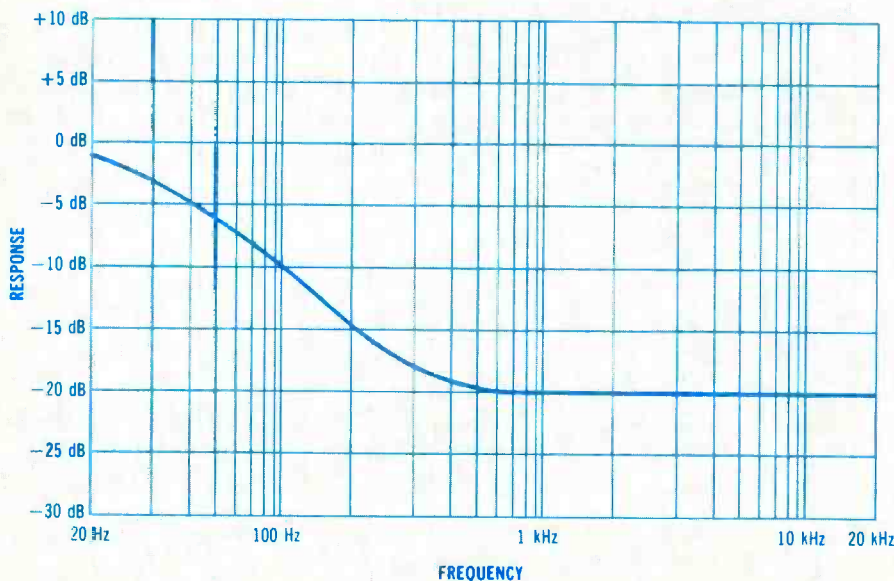
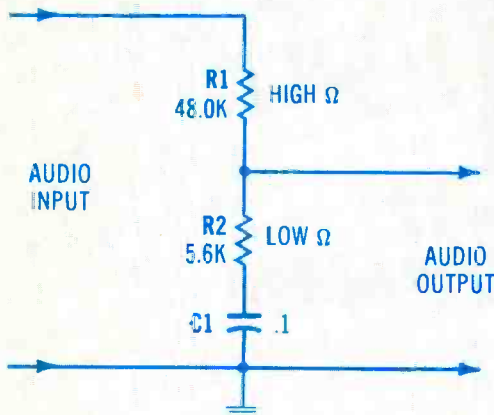

Figure 5. Adding a limiting resistor (R2) to Figure 4B can produce bass boost with flat treble response. These values give optimum bass boost and minimum loss for transistorized circuits. Loss at high frequencies is determined by the R1 and R2 values. The reactance of C1 rises at low frequencies, thus reducing the voltage-divider loss at those frequencies. By comparison, less loss equals a gain. Test equipment produced this curve for the circuit.

SWD-1 VIDEO CONVERTER

FOR CABLE TV



The SWD-1 Video Converter is utilized on cable TV systems to remove the KHz's signal from a distorted video (channel 3 in/out) and also pass thru the normal undistorted/detected audio signal. Rocker switch selects operating mode to remove KHz's distortion from the video or pass all other channels normally. Simple to assemble—less than 30 minutes. Pre-tuned. Input/output Channel 3. Impedance 75 ohms. 117VAC.

SWD-1 Video Converter Kit \$69.95

VTR ACCESSORIES

SIMPLE SIMON VIDEO STABILIZER



Simple Simon Video Stabilizer, Model VS-125, eliminates the vertical roll and jitter from "copy guard" video tapes when playing through large screen projectors or on another VTR. Simple to use, just adjust the lock control for a stable picture. Once the control is set, the tape will play all the way through without further adjustments. Includes 12V power supply.

VS-125 Video Stabilizer, wired Reg. \$4.95 **\$39.95**

NEW VCR Quality

MODULATOR

Not a Game Type Modulator
The MPS-1 Kit converts Video/Audio signals to a crystal controlled RF output for TV Channels 3 and 4. The MPS-1 Modulator inputs are designed to match all TV Cameras and VCR's and features a voltage regulated power supply, power switch and LED indicator. No Tuning Required. Operates on 117VAC.

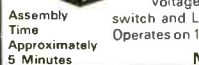

Assembly Time Approximately 5 Minutes

MPS-1 Kit \$39.95

UHF ANTENNAS and ACCESSORIES

MDS-AMATEUR-ETV 32 ELEMENT

YAGI ANTENNA



- Not A Kit
- 1.9-2.5 GHz
- 38 1/2" Long
- 23dB Average Gain
- Commercial Grade
- Die Cast Waterproof Housing with 4 1/4" x 2 1/2" Area for Electronics
- Includes P.C. Probe, F-61 Connector and Mounting Hardware

MAE-2 32 Element YAGI Antenna \$23.95

Kato Sons' Down Converter Kit ★ 1.9 - 2.5GHz ★

Designed for Simple Simon by former Japanese CO Amateur Magazine's UHF Editor/Engineer. Unit utilizes new ingenious Printed Circuit Probe for maximum gain. Circuit board fits inside MAE-2 antenna housing. Requires 1 hour assembly. IC and capacitors pre-soldered.

Model KSDC-KIT 1.9 - 2.5GHz Down Converter Kit \$34.95

Kato Sons' Regulated Variable DC Power Supply

For use with KSDC-KIT 1.9 - 2.5GHz Down Converter. Completely assembled with Attractive Cabinet, TV/Converter Mode Switch, Frequency Control and LED Indicator.

Model KSPS-1A Assembled Power Supply \$23.95

SPECIAL INTRODUCTORY SAVINGS

ORDER ALL THREE ITEMS

MAE-2, KSDC-KIT and KSPS-1A for Only **\$74.95**

Regular price if ordered separately \$82.85

CO-AX CABLES ARE NOT INCLUDED

ZYZZX VHF-UHF Wideband Antenna Amplifier



Revolutionary New HYBRID IC Broadband Amplifiers

50 MHz - 900 MHz Model ALL-1 12dB Gain Model ALL-2 35dB Gain

These units are not available anywhere else in the world. Each unit will serve many purposes and is available in Kit or Assembled form. Ideal for outdoor or indoor use. I/O impedance is 75 ohms. Amplifiers include separate co-ax feed power supply. Easily assembled in 25 minutes. No coils, capacitors to tune or adjust.

ALL-1 Complete kit w/power supply \$24.95 ALL-1 Wired/Tested w/power supply \$34.95
ALL-2 Complete kit w/power supply 34.95 ALL-2 Wired/Tested w/power supply 44.95

Our New STVA 14.5dB GAIN, 14 ELEMENT CORNER REFLECTOR YAGI ANTENNA



STVA-3 Yagi Antenna, 14.5dB Gain, Selectable 75 or 300 ohm Channel 60-80. \$19.95

STVA-4 Yagi Antenna, 14.5dB Gain, Selectable 75 or 300 ohm Channel 44-52. \$19.95

RG-59/U 75 ohm Low Loss Coax Cable \$1.29/ft. F-59 Coax Connector \$.39 ea.
MT-1 Special UHF 75-300 ohm Matching Transformer \$1.45 ea.

Switch to Bambi!™

Electronically

Bambi Electronic Video Switch ... makes switching of your VCR/VTR, Pay TV Decoders, Cable TV, Video Discs, Video Games, Closed Circuit TV, Antennae and Microcomputer as easy as pushing buttons.



The Bambi Electronic Video Switch is an electronic switching network which can accept up to six different sources of video signals and provide the flexibility of directing the inputs to any or all of the three outputs.

Now you can eliminate ... the drudgery of disconnecting and reconnecting your video equipment each time you use it ... the tangled mess of cables which are impossible to trace out ... not being able to use more than one function at a time

Bambi lets you enjoy using your video equipment the way it should be ... electronically and on line at the push of a button.

Model BEVS-1 Completely Wired and Assembled. Includes comprehensive Instruction/Operation Manual and Decal Set for customizing your Video Switch installation.

\$129.95



FREE Bambi Poster with any purchase



Bambi's front panel was designed with the user in mind. Computer styled construction, with soft-touch keyboard (rated for over 10 million operations), arranged in matrix form allows easy input/output selection without referring to charts. Functions selected through the keyboard are immediately displayed on the 18 LED status indicators.



Check the quality of Bambi against that of much higher priced competition. All solid state electronic switching provides low attenuation (3dB), wide frequency response (40-890 MHz), and excellent isolation between signal sources (each I/O section individually shielded for 65dB min. isolation).



Bambi's Specifications:

- Input/Output Impedance 75 ohm
- Signal Loss 3dB ±1dB
- Noise 4dB ±1dB
- Input Return Loss 12dB min.
- Isolation 65dB min.
- Power Req. 117VAC 60 Hz, 2W
- Dimensions 10" W x 6" D x 3" H
- Weight 4 1/2 lbs

7+11 SWD PARTS KITS

MITSUMI VARACTOR UHF TUNER

Model UES-A56F \$24.95



ITEMS 1-14 SPECIAL \$119.95

Freq. Range 148-470 - 889MHz

Antenna Input 75 ohms

Channels 14-83 Output Channel 3

Kit No.	PART No.	DESCRIPTION	PRICE
1	1VT1-SWD	Varactor UHF Tuner, Model UES-A56F	\$24.95
2	2CB1-SWD	Printed Circuit Board, Pre-Drilled	18.95
3	3TP11-SWD	P.C.B. Potentiometers, 1-20K, 1-1K, and 5-10K ohms, 7-pieces	5.95
4	4FR35-SWD	Resistor Kit, 1/4 Watt, 5% Carbon Film, 32-pieces	4.95
5	5PT1-SWD	Power Transformer, PRI-117VAC, SEC-24VAC, 250ma	6.95
6	6PP2-SWD	Panel Mount Potentiometers and Knobs, 1-1KBT and 1-5KAT w/Switch	5.95
7	7SS14-SWD	IC's 7-pcs, Diodes 4-pcs, Regulators 2-pcs, Heat Sink 1-piece	29.95
8	8CE9-SWD	Electrolytic Capacitor Kit, 9-pieces	5.95
9	9CC33-SWD	Ceramic Disk Capacitor Kit, 50 W.V., 33-pieces	7.95
10	10CT-SWD	Variable Ceramic Trimmer Capacitor Kit, 5-65pfd, 6-pieces	5.95
11	11L4-SWD	Coil Kit, 18mhs 2-pieces, 22µhs 1-piece (prewound inductors) and 1 T37-12 Ferrite Torroid Core with 3 ft. of #26 wire	5.00
12	12ICS-SWD	I.C. Sockets, Tin inlay, 8-pin 5-pieces and 14-pin 2-pieces	1.95
13	13SR-SWD	Speaker, 4x6" Oval & Prewound Wood Enclosure	14.95
14	14MISC-SWD	Misc. Parts Kit Includes Hardware, (6/32, 8/32 Nuts, 6 Bolts), Hookup Wire, Ant. Terms, DPDT Ant. Switch, Fuse, Fuseholder, etc.	9.95

When Ordering All Items, (1 thru 14), Total Price 139.95

7+11 PWD PARTS KITS

INTRODUCING OUR 7+11 PWD PARTS KITS

ITEMS 1-15 SPECIAL \$123.95

Kit No.	PART No.	DESCRIPTION	PRICE
1	1VT1-PWD	Varactor UHF Tuner, Model UES-A56F	\$24.95
2	2CB1-PWD	Printed Circuit Board, Pre-drilled	18.95
3	3TP11-PWD	PCB Potentiometers 4-20K, 1-5K, 2-10K, 2-5K, 1-1K, and 1-50K (11 pieces)	8.95
4	4FR-31-PWD	Resistor Kit, 1/4W, 5% 29-pcs, 1/2 W 2-pcs	4.95
5	5PT1-PWD	Power Transformer, PRI-117VAC, SEC-24VAC at 500ma	9.95
6	6PP2-PWD	Panel Mount Potentiometers and Knobs, 1-1KBT and 1-5KAT with switch	5.95
7	7SS17-PWD	IC's 7-pcs, Diodes 4-pcs, Regulators 2-pcs Transistors 2-pcs, Heat Sinks 2-pcs	29.95
8	8CE14-PWD	Electrolytic Capacitor Kit, 14-pieces	6.95
9	9CC20-PWD	Ceramic Disk Capacitor Kit, 50 WV, 20-pcs	7.95
10	10CT5-PWD	Variable Ceramic Trimmer Capacitor, 5-65pfd, 5-pieces	4.95
11	11L5-PWD	Coil Kit, 18mhs 3-pcs, 22µhs 1-piece (prewound inductors) and 2 T37-12 Ferrite Torroid cores with 6 ft. #26 wire	6.00
12	12ICS-PWD	I.C. Sockets, Tin inlay, 8 pin 4-pcs, 14 pin 1-pc and 16 pin 2-pcs	2.95
13	13SR-PWD	Enclosure with PM Speaker and Pre-drilled Backpanel for mounting PCB and Ant. Terms	14.95
14	14MISC-PWD	Misc. Parts Kit, Includes Hardware, (6/32, 8/32 Nuts & Bolts), Hookup Wire, Solder, Ant. Terms DPDT Ant. Switch, Fuse, Fuseholder, etc.	9.95
15	15MTC16-PWD	Mylar Capacitors, 14-pcs and Silver Mica Capacitors 2-pieces	7.95

When Ordering All Items, (1-15), Total Price 159.95

CUSTOMER NOTICE: BUY WITH CONFIDENCE... BEWARE OF LOW QUALITY IMITATORS. All of our kits consist of New, 1st Class, RF Quality, Parts Engineered for Optimum Operation, not factory seconds or stock close-outs. We service your completed kits that you've purchased and built. You will never get stuck with a BAG OF PARTS when ordering from Simple Simon.

SIMPLE SIMON ELECTRONIC KITS,™ Inc.

3871 S. Valley View, Suite 12, Dept. E, Las Vegas, NV 89103

NEED 6 OR MORE OF AN ITEM? WRITE FOR QUANTITY DISCOUNTS

In Nevada Call: 702-871-2892

1-800-782-3716

Outside Nevada Call:

Available by Mail Order Only
Send Check* or Money Order. Minimum Order: \$16.95. Add 10% Shipping and Handling on orders under \$40.00. For orders over \$40.00, add 5%. Minimum Shipping and Handling \$2.00. Cat. \$1.00 — VISA and Mastercard Acceptable — *Check orders will be held 30 days before shipping.

quencies is the same as if R1 were shorted so the input and the output were connected together. If the filter's driver had high impedance, the change from a low-frequency load of 53.6K Ω to a high-frequency load of only 5600 Ω would reduce the high-frequency output of the driver. Of course, such a HF loss would subtract from the HF gain of the filter.

The solution is to add a buffer resistor for the capacitor (Figure 6B). Because C1 now feeds a higher impedance circuit, the value must be decreased to obtain the same approximate curve (Figure 6C).

For optimum results, the Figure 6B HF-boost circuit should be driven by a stage having low impedance, and the following amplifier that accepts the filter's output signal should have a high input impedance (such as an emitter follower). These requirements are easily fulfilled by conventional transistor circuits.

The time constant and turnover frequency for the Figure 6A circuit were calculated and compared to the response measurements. According to the formula previously given, the time constant of R1 and C1 was 595 μ s, which calculates to a turnover frequency (where +3dB is obtained) of 267Hz. However, a careful recheck

of the actual response showed the +3dB turnover was 302Hz. These discrepancies illustrate why most designers use time constant and turnover calculations to obtain approximate component values, then build a prototype of the circuit and fine-tune the values for the desired results. As mentioned previously, the impedances of drivers and following amplifiers affect the precise results obtained by these filters.

The previous bass-boost and treble-boost filters were *cancelled-loss* types using only resistors and capacitors. Other filters include active devices such as ICs or transistors that supply phase inversion and gain and otherwise modify the filter operation. These various circuits are called *active filters* because of the active devices in them.

For example, Figure 7 shows a partial circuit that gives both treble and bass boost. (If needed, treble decrease can be accomplished by adding an appropriately sized capacitor from the Q1 base to ground. Bass decrease is possible by decreasing the values of coupling capacitors C1 and C5.) Similar circuits are used to amplify and equalize the small signal coming from the playback head in tape recorders.

Signal voltage from the Q2 collector is reduced in amplitude by resistor R3 and then applied to the Q1 emitter. Because of phase inversion in Q1 and Q2, the Q2 col-

lector signal has the same phase as the Q1 base signal. Also, the Q1 emitter is unbypassed, so the voltage-drop signal there has the same phase as the Q1 base. When the R3 sample of the Q2 collector signal is applied to the Q1 emitter, it increases the emitter signal amplitude (like phases add). But remember that the in-phase emitter signal is subtracted from the base-to-ground signal to form the *actual* base-to-emitter signal (the only signal the transistor amplifies). Therefore, Q1 has reduced B/E input signal that in turn reduces the Q1 collector, the Q2 base and the Q2 collector signal amplitudes. This is negative feedback, which provides the loss that can be cancelled to give the effect of a boost at certain frequencies.

C3 in Figure 7 reduces the amount of low frequencies in the negative feedback signal to the Q1 emitter. Therefore, the reduced feedback produces increased low-frequency response at the output from the Q2 collector. The amplitude of this bass boost depends in part on the value of R3, while turnover is determined by the C3 capacitance relative to the R3 resistance. Of course, a secondary advantage is that the negative feedback stabilizes the circuit gain, at least at middle and high frequencies, where the feedback is not reduced by boosting the bass.

High-frequency boost can be produced by adding a small capacitor (C2) from the Q1 emitter

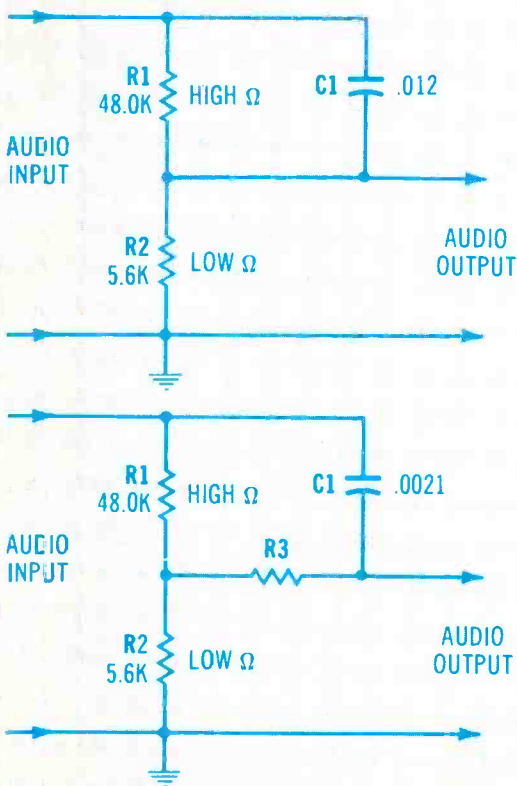
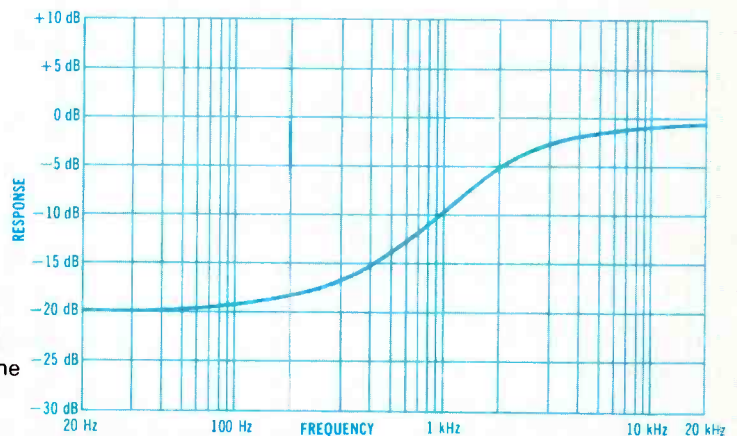

Figure 6. Treble boost (increase) can be obtained by eliminating the voltage-divider loss at high frequencies.

(A) At extremely high frequencies, the C1 reactance is near 0 Ω , which gives the effect of shorting together the input and output signals at those frequencies, thus removing the R1/R2 loss. But the circuit has one practical flaw: it presents a much lower high-frequency load to the circuit that drives it. The next circuit solves the problem. (B) Essentially the same response is produced by adding a 27K decoupling resistor (R3). Bass and middle frequencies pass through the R1/R2 voltage divider and then R3 before reaching the output. Treble frequencies pass through the 0.0021 μ F C1 directly to the output, without the R1/R2 loss, giving the effect of a treble boost as shown on the graph.



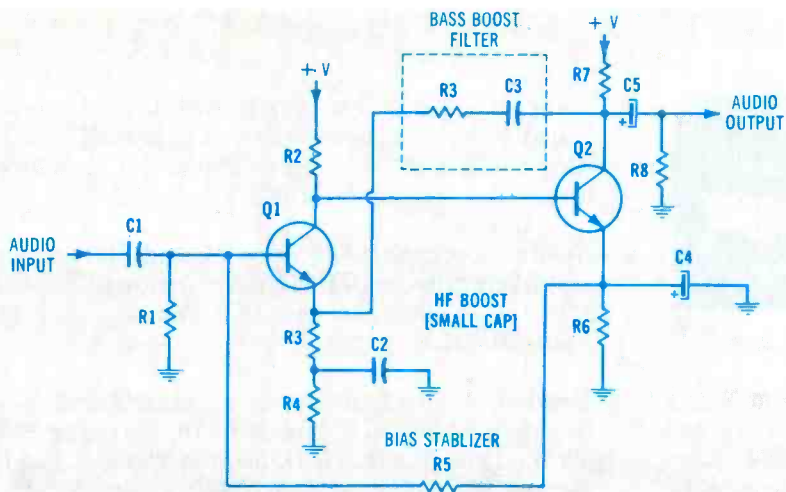

Figure 7. Bass boost and treble boost can be obtained by this circuit, which operates by applying negative feedback from the Q2 collector to the Q1 emitter. Then the feedback is reduced by C3 for bass and C2 for treble to allow normal gains of Q1 and Q2 at those frequencies. When used as playback-compensation preamplifiers, similar circuits often give unity gain (same input as output amplitude) at middle frequencies with a boost of perhaps 35dB at low frequencies plus whatever HF boost is needed (if any).

to ground, which reduces the negative feedback at high frequencies. Reduced HF boost can be obtained (Figure 7) by using two resistors in series from emitter to ground and connecting the HF-boost capacitor from the common point to ground.

A dc stabilization loop is also provided. The Q1 base dc voltage comes through R5 from the Q2 emitter voltage. If ambient heat changes the conduction of Q1 or Q2, the dc feedback through R5 restores it. For example, suppose one transistor's conduction changed, increasing the Q2 emitter voltage. A sample of the Q2 emitter voltage goes through R5 to the Q1 base, where it increases the forward bias and decreases the Q1-collector dc voltage, which is direct coupled to the Q2 base, decreasing it also. In turn, the lower Q2-base dc voltage decreases the Q2 emitter voltage to very near the original dc voltage. Of course, stabilizing the Q2 emitter voltage also stabilizes the Q2 collector dc voltage.

Applying time constant

Cassette tape specifications almost always includes two items: bias level and equalization. Normal-bias (class-1) tapes are standardized for operation with 120 μ S equalization, which is the amount of high-frequency pre-emphasis (Figure 3). Pre-emphasis for 120 μ s has a +3dB turnover at 1326Hz.

CrO₂-type higher-bias tapes are recorded with 70 μ s pre-emphasis, because the better high-frequency response permits flat playback with less equalization. Obviously, the reduced pre-emphasis minimizes the possibility of HF overload in the tape-recording circuits.

Playback equalization is also slightly different for 120 μ s-recorded and 70 μ s-recorded tapes. As stated before, only the playback curve is standardized (Figure 2). Therefore, various tape machines might use more or less pre-emphasis during recording to achieve flat response with the standard playback curve. Of course, some models might have high-frequency boost applied during *playback* in an effort to obtain better HF response. This is not recommended because playback HF boost increases the audible tape noise.

Mismatched bias and equalization

The four basic types of cassette tapes are designed to provide optimum performance in machines that apply the recommended bias level and equalization. We automatically adjust the machines for normal bias and 120 μ s equalization when a type-1 normal-bias tape is recorded. In the same way, CrO₂ higher bias and 70 μ s equalization are selected for class-2 CrO₂.

Some interesting response

variations can be obtained by selecting "wrong" bias and equalization. If a normal-bias tape is recorded with CrO₂ higher bias and type-2 70 μ s equalization, it will have greatly reduced high-frequency response (even when played back at correct settings) for two reasons. Higher bias reduces the HF response, and the 70 μ s equalization gives less HF boost during recording. Usually, the reduced treble is not desirable, but it is mentioned to complete the explanation.

On the other hand, a class-2 CrO₂ tape that is recorded with normal bias and 120 μ s pre-emphasis will have a large increase of high frequencies, even when played back at CrO₂ specs. This HF boost can be very useful if the recording is made to correct insufficient HF response of a disc record, a radio broadcast, or another tape. Of course, a short test should be made to make certain the HF correction is sufficient without being excessive.

Next article

Several years ago, when I first bought a good cassette deck, I believed the manufacturer had been untruthful about the frequency-response specifications. With class-1 normal-bias tapes, the deck was rated at 3dB up to 17kHz. However, listening tests proved beyond question that the HF response was weak, from about 3kHz and higher. The search for flat response required much time for several weeks before all the problems were identified and corrected.

All reputable manufacturers of cassette tapes provide specifications about the performance under specific conditions. Quite often, four to six curves for different parameters are shown on one graph. From a comparison of these specifications, it *should* be easy to find the tape that is best for your needs. Unfortunately, it seldom is easy.

However, evaluation of tapes should be one step nearer a science after the meanings of tape curves are explained in the next article and instructions are given for making easy frequency-response and amplitude tests of various tapes.

ES&T

Readers' Exchange

Needed: The following "recently out-of-print" Sams books at reasonable prices: 24033, Q&A for Commercial Radiotelephone License, and 23264, Electric Motors. *S.O. Sellers, 7308 Franklin Drive, Rock Creek, Bessemer, AL 35023.*

Needed: Deflection yoke #24G102-50A09 for Motorola b&w television, model #ZD5606JW, chassis, #TS597; Heathkit variac, kit #IP-5220; Heathkit curve tracer, kit #IT-3121. *James L. Young, 3502 Gondar Ave., Long Beach, CA 90808, 1-213-420-9832.*

Needed: Sams Photofact number TR-82 and Supremes R-2, 3 and 6 manuals. *C.T. Huth, 146 Schonhardt St., Tiffin, OH 44883.*

Needed: Simpson color generator, model \$432. *A. Orze, 757 Alameda, Youngstown, OH 44510.*

Needed: Crystal for a Zenith model BC-221-J frequency meter, EMC model 802 signal tracer/generator and Heath model IG-5237 FM generator. *Caswell Davis Jr., 601 Delmar, Apt. 2, San Antonio, TX 78210.*

Needed: Fourth video IF/4125MHz trap coil (marked 1044) for Milovac color receiver, model CT-711 (Sams 1159-1). *Bill Messina, 53 Railroad Ave., Norwood, MA 02062.*

Needed: IC-800 vertical-horizontal chip, part #56D53-1 (Sams 1714), for Admiral 19-inch television, model #19C7038, chassis #9M45-1A, made in Taiwan Oct. 18, 1976. Any help will be appreciated. *Joseph V. Bowie, 4120 Alton St., Bradbury Heights, MD 20743, 1-301-568-9318.*

Needed: Address for REM Electronic Instruments or power transformer #SYT 100-0149 for cathode recovery unit and CRT tester. *Martin Doucet, Doucet Radio & TV, Box 391, Beresford, NB, Canada E0B 1H0.*

Needed: Sync separator, PC1, part #250526-2 for a Magnavox T944 chassis (b&w television). Also 5UA1 rectifier tube and 1U4 tube for Zenith transoceanic radio 6A40 chassis. *Henry Ludzus, 23 Monroe St., Oakville, CT 06779.*

Needed: Hickok DVM MX331 or 334 and Hickok DVM LX303 or 304. *Ken Miller, 10027 Calvin St., Pittsburgh, PA 15235.*

Needed: New or used horizontal driver transformer, Panasonic part #TLH8042K, used in b&w model TR622U. *Capitol Radio & TV, 185 Park Road, West Hartford, CT 06119.*

Needed: Sencore VA48 video TV and VIR analyzer, PR57 Powerite and TF46 Super Cricket. *J. B. Allen, 5630-146 A St., Surrey, BC, Canada V3S 5L4, 1-604-596-5948.*

Needed: Most of the series of Sams/Audel books, (Servicing Admiral TV for 1975-76, Servicing Philco TV for 1974-75, etc.). *R.D. Redden, Route 9, Box 125, Beaver, WV 25813, 1-304-763-2915.*

For sale: Zenith #20Y1C48 color TV chassis, complete with tuner, controls, yoke convergence assembly, degaussing coil, etc. Perfect operating condition, make reasonable offer. *Jay's TV-Radio Clinic, 945 Clay Ave., Stroudsburg, PA 18360.*

For sale: Schematics for auto radios from the 1940s to 1960s, consisting of Delco, Motorola, Stromberg-Carlson, Phillips, Bendix, United Motors Service (General Motors), Philco and Sylvania. Also have schematics and service literature for televisions from the 1940s to 1960s, including Admiral, Arvin, Crosley, Dumont, Emerson, General Electric, Motorola, Philco, Quazar, RCA and Spartan. Most are in good shape and complete. All for \$175 or best offer; postage extra. *Ed Day, RFP #2, Box 184, Ox Brook Road, Claremont, NH 03743, 1-603-542-8191.*

For sale: Radio Shack TRS-80 model 1, 48K and RS-232 microcomputer, \$800 or best offer; Okidata microline-80 printer for TRS-80, \$200; RCA-RD signal generator, type WR-50B, \$45. *William Shevtchuk, 1 Lois Ave., Clifton, NJ 07014, 1-201-471-3798.*

For sale: B&K sweep generator, model 415, \$250; B&K CB generator, model 2040, \$200; B&K RF generator, model E200D, \$200. *Jeffrey Jeffers, 824 Breathitt Ave., Columbus, OH 43207, 1-614-497-2408.*

For sale: Approximately 980 new receiving tubes—24 b&w tubes, two 23-inch color tubes and two 25-inch color tubes—all in cartons. Also Sams 1-866 (incomplete, Riders Radio 1-23 and Riders TV, 1-15. Write for complete list. *Harvey Bennin, 2619 Wedemeyer St., Sheboygan, WI 53081.*

For sale: B&K TV analyst, model 1077B, excellent condition, complete, \$345. *David Marley, 134 Diller Road, New Cumberland, PA 17070.*

For sale: EMC model 212 transistor checker, like new, best offer; Sams 1-800, best offer; Vista digital crosshatch and dot generator, like new, best offer. *R. J. Horseley, 67 Theodore St., Buffalo, NY 14211.*

For sale: B&K 1075 TV analyst, \$50; RCA W056A 7-inch scope, \$50; Tektronix 316 3-inch scope, \$100. Plus shipping UPS. *Frank Dickinson, 496 Bulson-*

town Road, Stony Point, NY 10980, 1-914-786-2500.

For sale: Sams 1-1000, \$1000 plus shipping. *Florida Television Headquarters, 420 S. Dixie Highway, Hallandale, FL 33009.*

For sale: **Electronic Servicing** magazine from June 1969 through November 1982. Will take \$100, you pay postage. *George Otto, 1045 Magnolia Ave., Beaumont, TX 77701.*

For sale: Grid dip meter, EICO model 710 400KC 250 MC in eight overlapping ranges, 8 plug-in coils, 6AF4 colpitts oscillator. *D. Pollock, Box 217, Little Silver, NJ 07739.*

For sale: Sylvania CK 3000 color test jig with adapters, \$400, like new. *Al Dolgins, 1905 N. Woodley, Arlington, VA 22207, 1-703-524-2493.*

For sale: Antique VOM in oak case, by Electronic Measurements Corp., \$50; digital, portable, combustible gas detector #QII, by M.S.A., \$50; portable carbon monoxide indicator #I, by M.S.A., \$50. Free shipping in United States. *Richard L. Bednarcik, 28 Steele Ave., Lincoln Park, NJ 07035, 1-201-694-6374 (evenings).*

For sale: Heath IB-1102 frequency counter, like new, usable to over 120MHz, \$150; Heath IM-102 DMM, like new (IMM-102 matches IB-1102 in cabinet design), \$150; Conar 255 solid-state triggered scope, like new, \$150. All with manuals and probes. Will ship UPS collect. *Cecil F. Mott, 3 Mobil Land Court, Bloomington, IL 61701, 1-309-827-6867.*

For sale: Heathkit H8 computer with 24K and H9 video terminal. Also have complete CB transceiver test setup by B&K. Includes transceiver tester, signal generator, digital VOM and frequency counter. *Richard Vigue, Box 601, Waterville, ME 04901, 1-207-465-2592.*

For sale: EICO 460 oscilloscope, modified for triggered sweep; 5-inch, 4.5MHz; \$125. *Jim Kluge, 5951 S. Logan St., Littleton, CO 80121, 1-303-674-5576 (work) or 1-303-794-3988 (home).*

For sale: 167 volumes of Photofacts, AR-19 through AR-185; 83 tape recorder series, TR-6 through 89 (less TR-69); nine home tape player series, HTD-1 through HTD-9. Best offer. *John's Radio & TV Service, 29 S. Main, Clawson, MI 48017, 1-313-588-5530.*

Reader's Exchange items are listed free; limited to three items per person. "For sale" items must consist of used equipment, parts, etc., owned by individuals and not new items for sale by companies or manufacturers. If you can help with a request, please write directly to the reader, not to **ES&T**.

ES&T

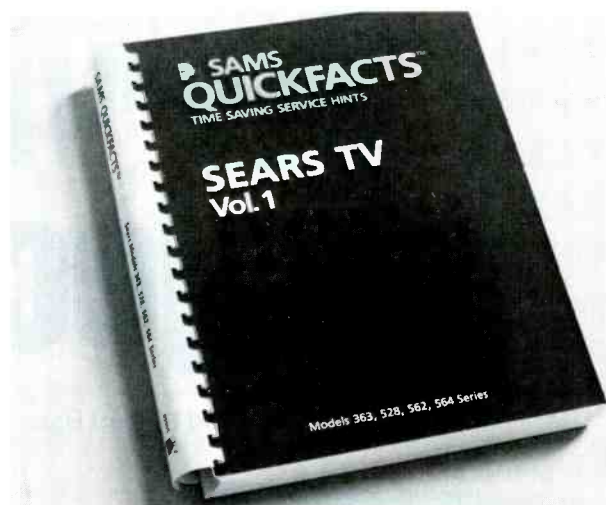

FOR TV SERVICEMEN... QUICKFACTS™ IS THE REFERENCE PREFERENCE.



Up-to-date technical information is essential to you as a professional service technician. That's why Howard W. Sams' new QUICKFACTS™ is quickly becoming an industry standard. It's the quickest, easiest, one-stop source for hundreds of TV service hints for the most frequently encountered service problems.

QUICKFACTS™ provides you with the answers in less than a minute.

- It's **PORTABLE**. QUICKFACTS™ compiles all of the important information into a few handy books which can easily be taken along on your service calls. There's less time wasted transferring a set back to your shop. Make more calls and profits in a day.
- It's **COMPREHENSIVE**. QUICKFACTS™ covers all makes and models. Since hints are organized by manufacturer, you only need to buy the books covering the manufacturers you service.
- It's **CROSS-REFERENCED**. Models contained in QUICKFACTS™ are cross-referenced to PHOTOFACT® numbers to further aid you in servicing.
- It's **ILLUSTRATED**. Photos point out each problem area to help make component location quick and easy.

Do yourself a service and add Sams QUICKFACTS™ to your list of service tools. QUICKFACTS™... the profitable servicemen's preference for technical servicing information.

For more information, or to order your QUICKFACTS™ volumes, see your local PHOTOFACT® Distributor, or call 800-428-3696 toll-free, or 317-298-5566 and reference AD240.

HOWARD W. SAMS & CO., INC.
4300 West 62nd Street, P.O. Box 7092
Indianapolis, IN 46206

Offer good in USA only. Prices subject to change without notice. In Canada, contact Lenbrook Industries, Ltd., Scarborough, Ontario.

Circle (11) on Reply Card

Servicing GE projection TVs

Adapted by Carl Babcoke from General Electric materials

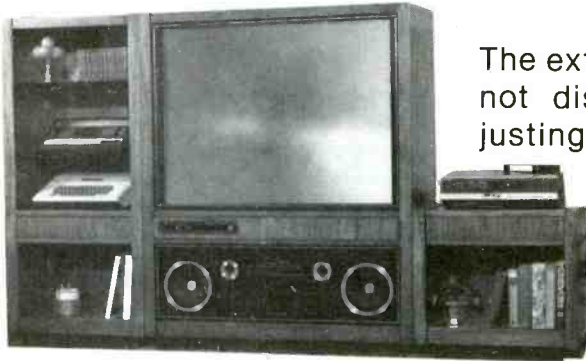

A one-piece projection color television, model 45EP1000.

The extra bulk of projection color TV receivers should not discourage technicians from repairing or adjusting them. Most of the specialized information needed for servicing the General Electric model 45EP1000 Widescreen receiver is provided here. Included are some troubleshooting tips and a complete convergence procedure. (Illustrations courtesy of General Electric.)

General Electric *Widescreen* TV models are rear-projection types with all components in one cabinet. The first Widescreen (introduced in 1978) included a single 13-inch, 3-gun, in-line color picture tube. Light from the picture tube traveled through a single plastic-lens assembly and was bounced from two front-silvered mirrors before striking the diffused rear surface of the 45.7-inch-diagonal plastic screen. Front-silvered mirrors have less light loss than do conventional rear-silvered ones, and because rear silvering results in two images: one faint ghost image from the front surface and the desired strong one from the silvered rear surface, front-silvered mirrors have much sharper images.

A fine-line circular pattern on the screen's rear surface forms a Fresnel lens that concentrates the light passing through so it enters the viewing area in straight parallel lines rather than scattering in all directions. This increases the brightness at the viewing position by reducing it in other areas where it is not needed. A flat Fresnel lens does the work of a heavier and thicker conventional convex lens. Details of the first

Widescreen optical path were given in the June 1978 issue of *Electronic Servicing* (page 14).

Later models had a similar optical path except that three picture tubes (red, blue and green) and three conventional lenses supplied three pictures to the first mirror. This gave increased picture brightness.

The following information applies only to the General Electric model 45EP1000, although some general methods can be used with other models because of their similarities. In the model number, incidentally, the 45 indicates a diagonal screen of approximately 45 inches, EP is the chassis number and 1000 is the individual identification.

The Widescreen can be divided logically into two basic sections: electronic/electrical and optical; and the electronic section can be further subdivided into signal-processing and deflection circuits. Efficient troubleshooting requires that any problem should be isolated initially to one of the three major areas (optical, signal or deflection).

Evaluating picture quality

Because projected pictures are much larger than directly viewed ones and the intensity of room lighting is seldom the same at different locations, it often is difficult to accurately judge brightness, sharpness and contrast of projec-

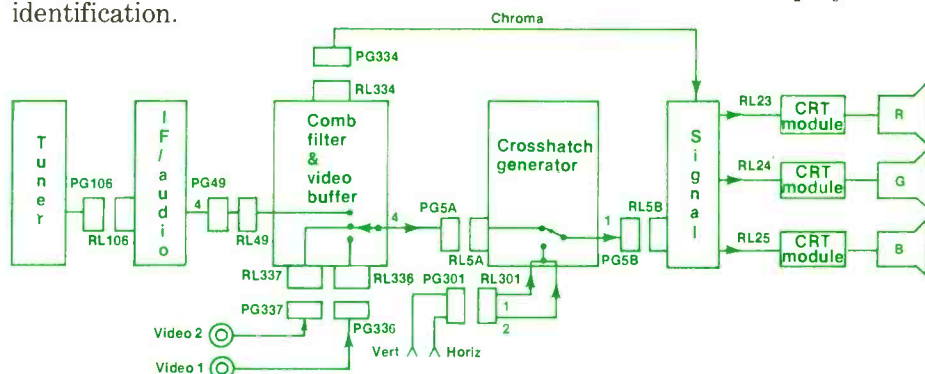

Figure 1. Signal path of the projection TV is shown by this block diagram. Notice the three picture tubes.

tion TV pictures. Generally, the picture should be viewed for evaluation from directly in front of the screen, between 10 and 20 feet from the cabinet. With room lighting of moderate intensity, the picture should have good color, brightness and contrast. Of course, as the viewer moves farther to one side (or up and down), it is normal for the brightness to decrease.

It would be a good idea for technicians to observe the brightness and picture quality of several individual, properly adjusted, rear projection receivers. This will enable them to judge more accurately picture performance in the future.

Operate the customer controls

The first step in any evaluation of picture quality should involve adjustments of the four front-mounted color registration (convergence) controls. Although, these controls are provided for customers to touch-up the convergence periodically, technicians can use them to estimate picture sharpness as well as convergence.

An internal crosshatch generator (Figure 1) produces a cross-hair pattern from one centered vertical line and one centered horizontal line on the screen. When selected by a front-panel switch, the crosshatch pattern can show the customer how to adjust the other convergence controls for best results.

Technicians can also use the crosshatch pattern to evaluate picture sharpness. Notice that each of the three 5-inch picture tubes has its own set of adjustments for deflection and convergence. Because each tube has just one color phosphor, it is impossible to obtain poor color purity, so no purity adjustments are required. (Neck shadow in one picture tube or deflection waveforms incorrectly entering one of the CRT modules can simulate poor purity when all three colors are on the screen. These defects are unlikely.)

Electrical focus

Electrical focus of the three picture tubes can be checked easily by misadjusting the front-panel convergence controls while the crosshatch is being viewed. Move the three cross-hairs apart enough

so that separate crosses can be seen. Carefully watch the green cross while adjusting the green electrical focus control to obtain the sharpest lines near the center, then do the same for blue and red.

If none of the three focus controls requires adjusting to one end of rotation, this is the best focus obtainable from the three electrical focus controls.

If at this point picture or line focus is substandard, or there is doubt about whether or not it is

normal, the optical focus should be tested for all three picture tubes.

Optical focus

Each picture tube is also provided with an optical focusing adjustment that is performed by moving the lens assembly.

With the crosshatch pattern spread apart into three separate crosses, loosen the wingscrew and make the same adjustment for red and blue lens assemblies.

START 1983 OUT IN THE RIGHT





DIRECTION









INTERNATIONAL TRANSISTORS
AND ELECTRONIC COMPONENTS

P.O. Box 1483
Union, N.J. 07083

NATIONWIDE: 800-526-4958
NEW JERSEY: 201-688-0300



<p>2SC867A.....\$2.95</p> <p>2SC1172B.....\$2.50</p> <p>2SC1308K.....\$2.25</p> <p>2SD313.....\$.45</p> <p>AN214Q.....\$1.50</p> <p>HA1377A.....\$3.25</p> <p>M51515BL.....\$3.25</p> <p>TA7205AP.....\$1.40</p> <p>UPC1181.....\$1.75</p> <p>UPC1182.....\$1.75</p>	<p>DELUXE T.V. GAME SWITCH</p> <p> \$1.95</p> <p>DTS-753</p> <p>F-59 CONNECTOR WITH BUILT ON FERRULE</p> <p> .14 ¢</p> <p>F-59</p>	
<p>SANYO 6 SECTION EXTENDS 37 1/2"</p> <p> ATO-375 \$1.45</p>	<p>TWO-WAY UHF/VHF HYBRID SPLITTER</p> <p> .95 ¢</p> <p>SPS-2</p>	<p>HIGH VOLTAGE TRIPLER</p> <p> \$11.99</p> <p>HVT-523</p>
<p>UHF/VHF/FM 2 SET COUPLER</p> <p> \$1.25</p> <p>UVF-2C</p>	<p>THREE-WAY UHF/VHF HYBRID SPLITTER</p> <p> .90 ¢</p> <p>SPS-3</p>	<p>MATCHING TRANSFORMER</p> <p> TMT-300 .46 ¢</p>
<p></p> <p>ATR-438 4 SECTION. OPENS TO FULL 38" .75</p> <p>ATR-538 5 SECTION. OPENS TO FULL 38" .75</p> <p>ATR-742 7 SECTION. OPENS TO FULL 42" .75</p>		

Circle (12) on Reply Card

Cleaning optical components

If the receiver has been exposed to dust or cooking fumes for a considerable period of time, deposits such as dust, grease or dirt may have been deposited on the picture-tube faces, the lens

elements or the mirrors. Such coatings can produce a reduction of contrast by causing optical flare (light without shape added to the black areas) and a loss of brightness.

All these surfaces can be cleaned

satisfactorily, but *extreme care must be used to prevent damage to them*. Cleaning should *not* be performed unless it is actually needed.

Dirt or dust particles (without any oily scum) usually can be removed from picture-tube screens and lens surfaces by a light dusting with a clean, soft, lint-free cloth.

If a cleaning agent is needed to remove grease, the strength should be greatly diluted with water. The lens surfaces have a special *optical* coating, so only light pressure with a minimum of rubbing should be used in order to avoid scratching or removing the coatings. Be certain to re-install any dust gaskets or blower filters that might have been removed during cleaning.

Front-silvered mirrors can be cleaned with water and mild soap, if necessary, but they are susceptible to scratches.

If the large front screen requires cleaning, first try a soft, dry cloth applied gently. The rear surface of the screen should be cleaned by a rotary motion of the cloth, while the front (viewing) surface should

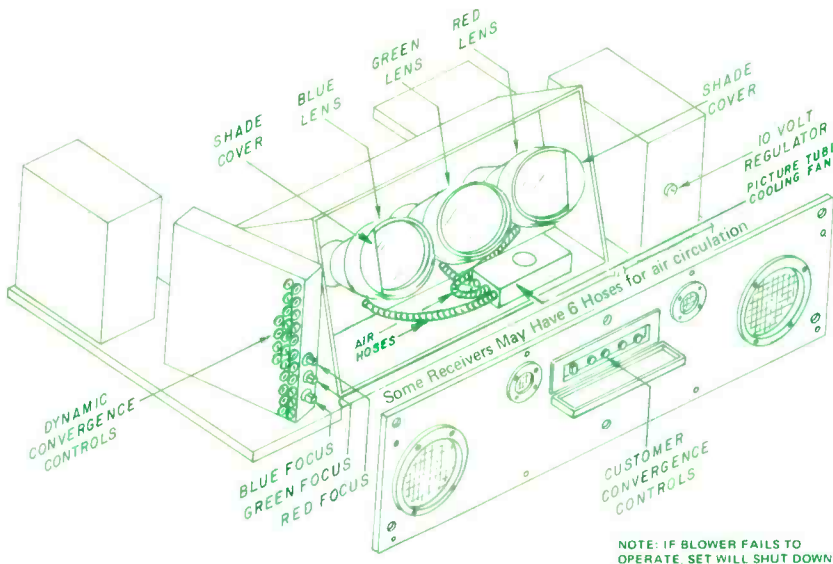

Many locations of adjustments and components are shown for the chassis assembly and the speaker panel. After several screws are removed, the speaker panel can be removed, although still connected, thus allowing access to the dynamic-convergence controls and focus adjustments.

JAPANESE SEMICONDUCTORS

SANYO
STK-435
\$4.10



SANYO
STK-437
\$6.50



ZENER DIODE KIT
ZDK-23
Most popular zener diodes in kit of 23
Plastic Cabinet

\$11.95



SANYO
2SC1308K
\$1.99



TOSHIBA
2SC1172B
\$1.99



TRANSISTORS	A808 3 18 A840 1.44 A908 10 47 A483 3.57 A489 1.54 A490 81 A495 16 A496 45 A509 36 A545 41 A606 1.99 A607 1.28 A626 3.66 A627 2.03 A634 54 A661 36 A682 50 A684 32 A690A 64 A705 58 A706 1.26 A719 20 A722 20 A738 43 A740 2.35 A745A 6.64 A747 7.02 A747A 7.50 A748 92 A750 14 A762 4.15 A771 2.08	B697 3.23 2SC352A 2.73 C371 32 C372 16 2SB22 25 B15 28 B173 32 B202 1.04 B220 1.00 B257 32 B303 32 B324 36 B367 1.85 B407 1.22 B426 1.22 B448 1.72 B474 1.12 B507 60 B509 2.15 B511 64 B528 66 B529 66 B536 90 B537 90 B541 2.71 B555 3.09 B556 5.35 B557 2.93 B561 18 B595 24 B617A 1.35 B656A 3.84	C789 1.20 C799 1.50 C829 14 C830H 2.71 C836 14 C839 20 C840 1.62 C867A 2.80 C87A 34 C388A 52 C394 18 C458 14 C466 1.99 C495 52 C496 45 C497 1.56 C509 32 C517 4.40 C537 16 C563 63 C627 1.28 C642A 3.86 C696 1.36 C708 1.51 C710 16 C732 14 C733 14 C735 28 C756A 1.40 C781 1.99 C784 28 C785 28	C789 1.20 C799 1.50 C829 14 C830H 2.71 C836 14 C839 20 C840 1.62 C867A 2.80 C87A 34 C900 20 C941 25 C945 11 C959 1.17 C960 1.10 C1012 1.36 C1025 90 C1034 5.60 C1047 18 C1050 1.71 C1061 56 C1096 40 C1114 3.45 C1115 4.06 C1116A 4.13 C1124 99 C1127 1.90 C1161 1.95 C1166 50 C1169 5.69 C1172B 1.99 C1173 52 C1209 28	C1212A 58 C1213 18 C1215 28 C1226A 40 C1239 1.50 C1279 40 C1306 97 C1307 1.72 C1308K 1.99 C1345 16 C1318 18 C1330 53 C1346 43 C1383 27 C1384 29 C1403A 3.21 C1413A 4.97 C1419 56 C1448 1.20 C1567A 56 C1664A 2.00 C1675 14 C1678 81 C1681 1.05 C1728 28 C1760 82 C1815 11 C1816 2.26 C1885 36 C1894 35 C1951 1.44	C1959 30 C1973 61 C2028 58 C2029 1.53 C2074 97 C2166 97 2SD24V 80 D72 65 D92 166 D93 1.72 D157 2.51 D226A 1.43 D180 1.89 D187 2.03 D201 2.49 D226A 1.43 D234 82 D235 82 D267A 2.97 D313 45 D315 1.02 D350 3.99 D353 2.82 D357 61 D358 66 D381 76 D386A 79 D424 2.03 D425 3.03 D426 2.89 D438 34 D467 16 D468 16	D470A 2.51 D471 26 D525 90 D526 81 D555 4.51 D586A 1.10 D588A 1.71 D600 45 D613 60 D733K 250 D823 94 2SK19 45 2SK30A 34 2SK30B 76 HA1356W 1.89 HA1342A 1.84 HA1361 2.04 HA1399 1.62 HA1339A 1.84 HA1366WR 1.89 AN2140 1.50 AN239 5.43 AN247 2.99 AN274 2.25 AN313 2.79 AN315 2.00 AN362 1.41 AN374 99 AN812 1.35 AN7145 2.46 AN7150 2.33 BA514 1.44 BA521 1.23 BA532 1.62 BA1310 1.56 HA1137W 1.12	HA1138 1.36 HA1156W 1.26 HA1196 1.36 HA1197 1.28 HA1199 1.43 HA1201 76 HA1202 94 HA1306W 2.08 HA1319 2.75 HA1329 1.62 HA1339A 1.84 HA1342A 1.84 HA1361 2.04 HA1399 1.62 HA1356W 1.89 LA1365 1.26 LA3350 1.10 LA4032P 1.86 LA4400 1.80 LA4430 1.36 M51513L 1.89 M51515BL 3.05 MB3705 1.54 MB3712 1.51 M51516L 1.44 MB3756 1.99 MB3871 4.78 PL101A 3.86 PL102A 6.34	STK0029 3.88 STK0050 5.87 STK0080 10.60 STK013 7.70 STK015 3.20 STK032 7.65 STK040 7.42 STK043 8.80 STK078 7.75 STK080 7.85 STK430 5.50 STK433 4.00 STK435 4.10 STK437 6.50 STK439 6.80 STK463 9.65 STK502 2.93 STK503 7.50 TA7055P 1.99 TA7060P 7.70 TA7081AP 96 TA7083 1.80 TA7074P 2.05 TA7075P 2.05 TA7076P 3.39 TA7120P 58 TA7130P 97 TA7201P 2.03 TA7203P 2.30 TA7204P 1.35 TA7205AP 1.28 TA7214P 3.41	TA7222AP 1.87 TA7222PK 4.04 TA7310P 1.02 TC4081P 58 TC5080P 5.42 TC5081P 2.19 TC5082P 2.19 UHC1001 4.07 UHC1003 4.07 UHC1004 4.07 UHC1005 4.07 UJC41C 2.19 UJC41E 2.19 UPC157A 2.19 UPC554C 2.15 UPC555H 45 UPC571C 2.44 UPC575C2 1.10 UPC575H 3.18 UPC577H 72 UPC592H 52 UPC1001H 2.89 UPC1006C 2.44 UPC1016C 2.44 UPC1020H 2.89 UPC1025H 4.06 UPC1026C 88 UPC1032H 72 UPC1154H 2.43 UPC1155H 1.69 UPC1156H 1.69 UPC1181H 1.28 UPC1182H 1.28	UPC1185H 3.11 UPC1186H 1.56 UPC2002 1.43 UPC14305 1.74 UPD857 6.50 UPD858 8.50 UPD861C 5.87 GH3P 89 SID30-15 1.39 IN60 14/100 IN4001 10/100 IN4002 12/100 IN4003 12/100 IN4004 12/100 IN4005 15/100 IN4006 16/100 IN4007 20/100 SILICON RECTIFIER 25 Amp-1000 Volts SL-100 10/100
--------------------	--	---	---	--	---	---	---	---	---	---	---

OMNITRON

ELECTRONICS
770 Amsterdam Ave., New York, NY 10025

▶ Also ask for Free 100 Page Catalog ◀

Send Purchase Order, Check or Money Order
or Call Toll Free 800-223-0826

in NY STATE (212) 865-5580

All ORDERS SHIPPED UPS/COD F.O.B., N.Y.C.

MASTER CARD • VISA

Circle (13) on Reply Card

be cleaned by an up-and-down motion.

Do not use any window cleaners, abrasive cleaners, furniture polish, wax or any cleaner that leaves a residue.

Testing color picture quality

If the electrical focusing, the optical focusing and the optical-component cleanings have been performed, but the picture remains substandard, the color pictures from each of the projection tubes must be compared.

Remove the front grill, remove the speaker board and lay it in front of the receiver without disconnecting any wires. Cover two of the picture lenses with an opaque cloth, so only one color reaches the screen. Adjust brightness, picture and focus for the best-possible picture.

Repeat procedure for each of the other two tubes.

Evaluate the picture quality of these three colors. If all are poor, the source of the degraded pictures probably is in the signal circuits that are common to all three color signals. However, if one or

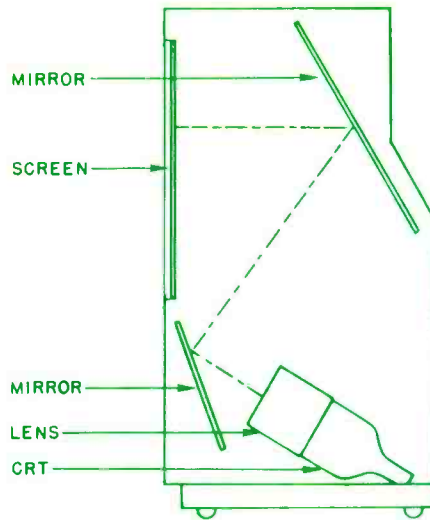

This side view shows how the three color pictures from the CRTs and their lenses are bounced from two front-silvered mirrors before reaching the screen's diffused rear surface and forming a picture that is visible from the front.

two of the pictures has degraded quality, the CRT module of the picture tube for that color might be defective.

All three 5-inch picture tubes are identical (except for the phosphor color) and all three CRT modules

are identical. Therefore, you can unplug the CRT socket board from the CRT that has the bad picture and cross-switch it with the socket-board of another CRT. If the poor picture follows the socket-board, the defect is in the board or the circuits preceding it. If the poor picture remains with the same color, the picture tube is defective.

In the unlikely event that no definite diagnosis can be made from the previous substitution test, you should remove one lens at a time and look at the picture quality directly on the CRT faceplate.

Remove the lens by folding down the corners of the foam seal and then removing the mounting screws for that lens. Be careful not to tear the seal material with the wingscrew or the mounting ears. (Not all models have the foam seal.)

Turn on the power and observe the CRT faceplate while adjusting the brightness, picture and focus controls for the picture tube under inspection. Insufficient brightness with blurred focus might indicate weak emission. Other problems

IN OUR CONTINUING EFFORTS TO SERVE YOU...

From time to time, Intertec Publishing Corp. makes its subscriber lists available to carefully screened companies or organizations whose products, services, or information may be of interest to you. In every case, list users must submit their promotional material for approval. They may use the list only once.

No information other than name and address is ever divulged, although names may be selected by segments to which the particular offer might appeal.

We are confident that the majority of our readers appreciate this controlled use of mailing lists. A few people may prefer their names not be used.

If you wish to have your name removed from any lists that we make available to others, please send your request, together with your mailing address label to:

Direct Mail Mgr.
Intertec Publishing Corp.
P.O. Box 12901
Overland Park, KS 66212

FINALLY. COMPUTERS AS A NEW TOOL FOR T.V. REPAIR.



Primefax puts computer-assisted repair capability in your shop today.

Primefax drastically reduces the number of sets requiring extensive trouble-shooting procedures. Through the use of today's technology, Primefax maintains—in a central computer—a database of problem-solving solutions for television set malfunctions. Primefax is a compilation of the most current, applicable technical information acquired from hundreds of valuable sources... and updated daily.

With a Primefax Computer Terminal installed in your shop, you can do your job more quickly and more

accurately. You have more satisfied customers, and your profits are increased substantially.

Reduced call backs • faster turn-around • reduced chance of repeated failure • more thorough service and complete repair at reasonable cost.

The more Primefax is used, the more profit you realize.

CALL US OR WRITE. No matter how you compute it, Primefax means profit for you. It's worth looking into.

In Texas, call (512) 344-5999 • Out of Texas, call 800-531-5953



4825 Fredericksburg Road • San Antonio, Texas 78229

Circle (14) on Reply Card

might indicate defects in the associated circuitry.

Remember that the optical system only transmits and enlarges whatever is on the CRT faceplate of each picture tube. Poor visual quality at the CRT screen cannot be corrected by optical focus adjustments or the cleaning of optical lenses, screen or mirrors.

Troubleshooting signal circuits

When the customer's complaint is a loss of picture, remember to check the mode-switch position. If it has been turned accidentally to "external input", there will be no picture. Also, check the normal/cable switch at the rear of the receiver.

A loss of video in the IF stages can be verified by switching to the customer's crosshatch pattern. If a station can't be seen or heard in the normal position, but a normal crosshatch is obtained in that mode, the tuner of IFs are dead (or the mode or cable switch is in an incorrect position). A normal crosshatch pattern proves the video and CRTs are operative.

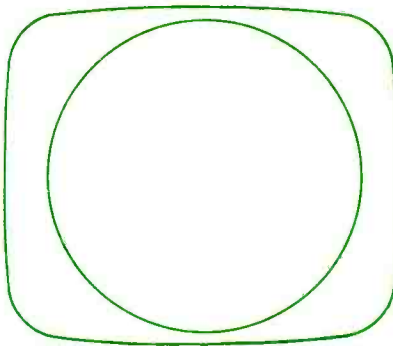

Figure 2. Convergence of red, blue and green pictures should be virtually perfect within the screen area shown by the circle. Some color fringing on monochrome programs or crosshatch may be visible outside of the circle.

Troubleshooting in all signal circuits is identical to that used for conventional direct-view color receivers.

Of course, misconvergence can simulate narrow bandwidth of signal circuits, showing a blurred picture. Therefore, be prepared to perform all convergence adjustments when needed. Notice that Widescreen convergence is different from that of conventional direct-view consoles.

Convergence facts

The Widescreen 45EP2000 has no static convergence adjustments. Complete convergence should not be needed except for one of these reasons:

- Someone has misadjusted all the controls
- One or more neck components have been moved
- A CRT has been replaced
- A sweep component (yoke, sweep board, convergence board, etc.) has been replaced

Usually, the convergence should be very good within the circular area shown in Figure 2, but some misconvergence will be noticed outside the circle.

The green-phosphor picture tube is at the center of the three, so it requires fewer adjustments. In fact, it is used as a standard after it receives several preliminary adjustments. The red and blue pictures are then adjusted to converge with the green.

Shortcuts to convergence

When complete dynamic convergence is needed, the following presetting of controls will simplify

DESOLDERING SOLDER EXTRACTOR

- Easy-to-Operate Control Center is Compact
- Desoldering Vacuum Operates on Shop Air
- Controlled Heat and Vacuum are in the Same Handpiece Tip
- Easily Releases Components from Double-Sided PC Boards
- Superior Technical Manual

PNEUMATIC TRANSDUCER OR SELF-CONTAINED PRINTED CIRCUIT REPAIR & REWORK

BEFORE: Pad and Eyelet are missing.

AFTER REPAIR with SRS-050 Kit, the Pad and Eyelet have been neatly replaced.

A.P.E.
Automated Production Equipment Corp.

142 Peconic Ave., Medford, N.Y. 11763 (516) 654-1197 TWX 510-228-2120

ECG • REN • GE • SK

REPLACEMENT TYPES

Why pay their high prices??

CHECK THIS!

IDENTICAL REPLACEMENT FOR ECG®
(Min. 5 pcs. each)

ECG® Type No.	YOUR PRICE	ECG® Type No.	YOUR PRICE
123A	.28	500A	8.95
152	.60	523	10.75
153	.65	526A	10.95
165	2.25	HIDIV-1®	3.75
238	2.25	HIDIV-3®	3.75

3 YEARS WARRANTY ON EXR PARTS

SPECIAL (Min. 5 pcs. each)

2SC867A	2.95	AN214Q	1.50
2SC1034	5.95	STK439	7.25
2SC1114	3.45	UPC1181H	1.95
2SC1308K	2.25	UPC1182H	1.95

Call Toll-Free 800-526-4928
COD ORDERS WELCOME (Min. order \$25)

CALL OR WRITE FOR OUR 1982 PRICE LIST

DIGITRON ELECTRONIC

110 Hillside Avenue, Springfield, N.J. 07081
201-379-9016 201-379-9019

ECG IS A TRADE MARK OF PHILIPS ECG.
DIGITRON IS NOT ASSOCIATED IN ANY WAY WITH PHILIPS ECG.

Circle (15) on Reply Card

Circle (16) on Reply Card

the process.

- Preset the customer convergence controls to their mechanical center.
- Preset the dynamic convergence controls according to Figure 3.

Preliminary convergence

During initial convergence adjustments, place a cloth over the screen externally to block out room light, then look at the *inside* of the screen through the viewing-screen peephole and make adjustments from the *rear* of the receiver. Follow these steps.

- Connect an external crosshatch generator to the antenna terminals, and adjust it for a single cross at the screen's center.
- Cover both red and blue lens.
- Operate the *green horizontal-centering ring* on the green CRT neck (Figure 4) to center the cross horizontally. Begin with the centering tabs together at top of the CRT neck, then spread the tabs to center the raster horizontally. Be sure to move the tabs equally to each side, otherwise the raster will be

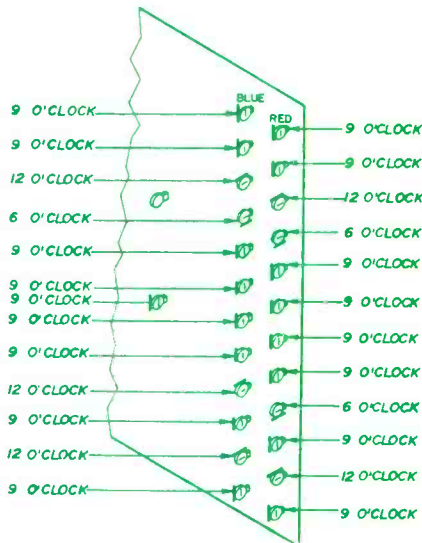

Figure 3. Before a complete dynamic convergence is begun, the controls should be preset as shown here.

shifted vertically.

- Adjust green *vertical-centering control* R652 to center the cross vertically.
- Switch the generator to its crosshatch pattern.
- Adjust these controls for a properly proportioned crosshatch pattern: green width

coil L1706, master vertical-size control R605 and green centering control R652.

- Uncover the red lens and perform the next four steps to superimpose the red pattern on the green.
- Adjust the red centering rings on the CRT neck for horizontal centering (review the previous step about adjusting the green cross centering).
- Adjust R682 red vertical-centering control so the center horizontal line has perfect red and green convergence at the horizontal center.
- Adjust the red-width coil L1707 to converge the red vertical lines with the green vertical lines at both sides.
- Adjust R608 red vertical-size control for proper height that converges all horizontal lines near the center.
- Uncover the blue lens and cover the red lens. Using the blue centering rings, R622 blue vertical-centering control, and L1705 blue-width adjustment, perform the same adjustments for the blue crosshatch as previously

ATTENTION TECHNICIANS

- ★ JOB OPENINGS
- ★ MONTHLY TECHNICAL TRAINING PROGRAM
- ★ BUSINESS MANAGEMENT TRAINING
- ★ LOW COST INSURANCE
- ★ CERTIFICATION
- ★ TECHNICAL SEMINARS

All of this in a nonprofit international association for technicians

FIND OUT MORE:



R.R. 3 Box 564
Greencastle, IN 46135

CRAIG

Star View

Systems™

STAR VIEW MODEL 12K

- Complete System
- Easy to Install
- Reasonably Priced
- UPS Shippable
Weight 125 Pounds
- More than 100
Channels Accessible

THE STAR VIEW 12K SYSTEM KIT CONTAINS:

- 12 Foot Antenna
- Azimuth Elevation Mount
- 24 Channel Receiver
- 120° Low Noise Amplifier
- Feed Horn
- Cables & Connectors
- No Modular Included

(May be ordered separately for \$79.95)

\$2595.00

Available through your local Craig Star View dealer • Call or write for information • Dealership inquiries welcome • Price subject to change without notice.

H&R COMMUNICATIONS, INC. Subsidiary of Craig Corp.
Route 3, Box 103G
Pocahontas, Arkansas 72455

Call 800-643-0102
or 501-647-2291

Circle (24) on Reply Card

done for the red.

- Uncover the red lens and judge the convergence.

The crosshatch now should be converged (as shown in Figure 5) in these areas:

- center of the screen (area 1),
- center of the top horizontal line (2),
- center of the bottom horizontal line (3),
- center of the right-edge vertical line (4) and
- center of the left-edge vertical line (5).

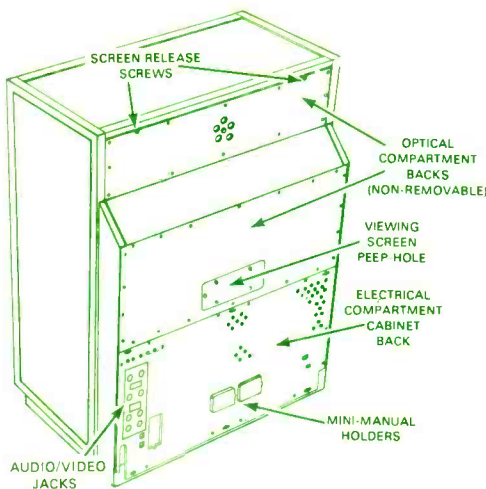

Arrows show locations of important components on the receiver's back side. Notice the two screws at top that release the viewing screen so it can be removed.

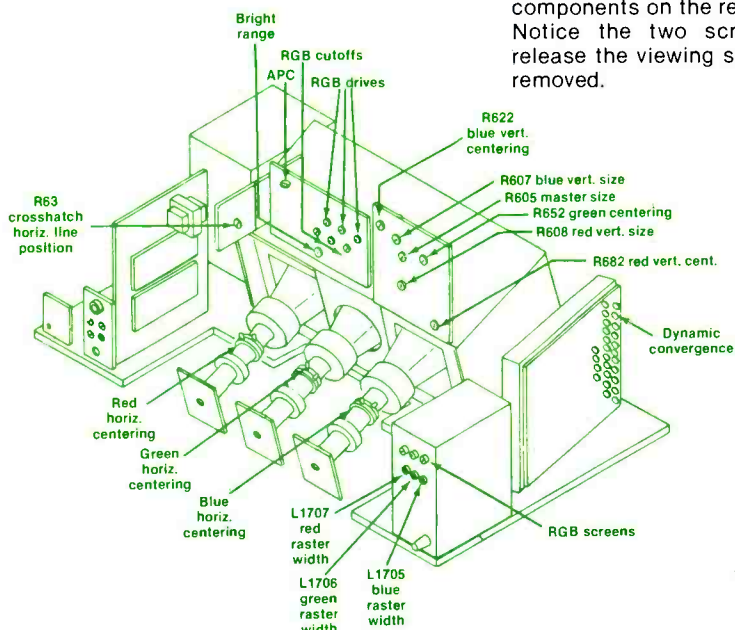

Figure 4. Locations of many important adjustments are pointed out on the EP chassis.

Figure 5. Numbers show the best sequence of preliminary dynamic convergence adjustments at these five areas. For example, point one is center convergence of the crosshatch. Points two and three are the centers of horizontal lines at the extreme top and bottom. Points four and five are the middles of vertical lines at the extreme edges.

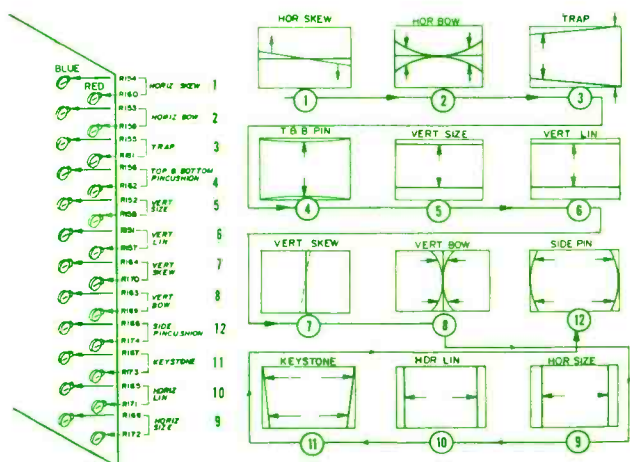
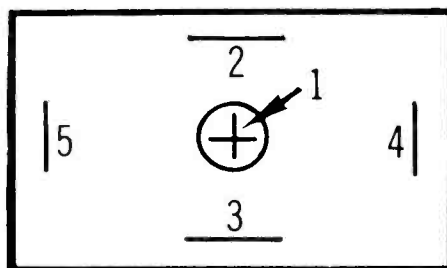

Figure 6. Use this sequence for final dynamic-convergence adjustments. For best results, repeat all adjustments.

Perfection is not essential at this point, because later adjustments will change these conditions slightly as they correct such problems as skew, bow and keystone.

Final convergence

Move to the front of the television and remove the cloth. Working through the space provided by removal of the speaker panel, cover the blue lens with the opaque cloth.

Use the sequence of Figure 6 to converge the red crosshatch lines onto the green crosshatch lines. Be certain to watch the proper lines while adjusting each control; for example, observe the center horizontal line when adjusting horizontal skew and horizontal bow and watch the top and bottom horizontal lines when adjusting trapezoid, vertical size, top-and-bottom pincushioning, etc.

Readjust the customer convergence controls as required to keep the center lines converged.

Uncover the blue lens and cover the red lens. Adjust the blue dynamic controls, following the Figure 6 sequence.

Finally, repeat all of these final convergence steps.

Comments

Lead and lead-loaded-vinyl shielding materials are attached permanently to all three picture tubes. The X-ray shielding materials also cover the CRT-anode button. Therefore, the high-voltage wire and connector are attached permanently to each picture tube. Do not attempt to remove them.

A blower and hoses are provided to cool the CRTs. If the blower fails to operate, the television will shut down automatically. This is an important point for troubleshooting.

Except for the three picture tubes and the large optical system, the General Electric Widescreen model 45EP1000 is very similar to conventional direct-view models. Most of the major differences and special adjustments have been explained here. Armed with this information, no competent television technician should be reluctant to service Widescreen projection televisions.



Books

The Second Book of Electronics Projects, by John E. Traister; Tab Books; 80 pages; \$4.50.

This step-by-step handbook has fascinating electronics projects and experiments for both beginners and more advanced hobbyists. Here's all the over-the-shoulder help anyone needs to build a variety of practical circuits and devices that really *do* something—everything from a direct-connection telephone amplifier to an electronic ammeter, and from a dc input for an ac oscilloscope to a fixed-output microphone mixer.

Anyone looking for a source for projects that will help teach them electronics theory and practice while they build actual working devices will find this an ideal handbook. It starts with clear, concise

explanations of basic hands-on experience in building the power supplies needed for the devices that are to be put together. From there on out, the emphasis is on making a variety of interesting and useful items like an IC dual-voltage power supply (with practical hints on how to troubleshoot and modify it), a single-channel light organ, a high-to-low microphone impedance converter, and an IC microphone amplifier with compression.

Tab Books, Blue Ridge Summit, PA 17214.

16-Bit Microprocessors, by Christopher A. Titus, Jonathan A. Titus, Leo J. Scanlon, Will Hubin and Alan Baldwin; Howard W. Sams; 352 pages; \$14.95.

This is a guide for those who are interested in 16-bit microprocessors, but don't have the time to wade through all of the manufacturer's literature.

The authors, experts in the field, help you understand, evaluate and compare the most popular of the 16-bit microprocessors now ap-

pearing on the market. The 8076 (Intel), the Z8001 and Z8002 (Advanced Micro Devices and Zilog), the 9900 (Texas Instruments and AMI), the LSI-11 (DEC), the 68000 (Motorola and Rockwell International) and 16000 (National Semiconductor) are discussed and illustrated.

The book provides software benchmarks that can be used to compare processors, and benchmark specifications are covered in the appendix.

Basic microcomputer concepts ranging from executing programs to instruction sets are presented in the first chapter. The actual program listings are covered in the remaining chapters.

Addressing modes and instruction sets for each microprocessor are given, and interfacing and I/O software examples are provided for the various chips. The book explains the hardware and software support that the manufacturers have for their products.

Published by Howard W. Sams & Company, 4300 W. 63rd St., Indianapolis, IN 46268.

BS&C



Outstanding Features:

- 1 mV sensitivity
- 6 KV acceleration potential
- Patented, ultra stable "auto fix" trigger circuit
- Reliability measured in excess of 15000 hrs. MTBF
- 2 year warranty, all parts, labor

...MORE THAN MEETS THE EYE!

SOLTEC® **SERIES 5 OSCILLOSCOPES**

Look on the inside of any Soltec Oscilloscope! . . . You'll see quality engineering and craftsmanship in a configuration that performs to your needs and expectations.

We offer a complete line of quality scopes to meet your exact needs. 12 MHz – 15 MHz – 20 MHz – 30 MHz (shown) 40 MHz – 60 MHz and 100 MHz, single, dual, triple and quad trace. . . all at competitive prices and available off-the-shelf from a distributor in your area.

Write or call for a full color descriptive catalog or the name of the distributor in your area.

800-423-2344

California residents call (213) 767-0044

SOLTEC® **CORPORATION**

11684 PENDLETON STREET
SUN VALLEY, CALIFORNIA 91352

Circle (19) on Reply Card

A control system primer

By Joe Carr

Electronic control systems represent a large portion of the servicing work of many electronics technicians in industrial, medical and military electronics. Examples of electronic control systems in more mundane applications are the thermostat in your home, the phase-locked loop in your television or CB, and the electromechanical control system in VTRs. The basic concepts of control systems are called feedback theory when dealing with amplifiers, but the effect is the same.

The mathematics of control systems is complex, and a subject taught on the advanced levels in

undergraduate electronic engineering and electronic technology courses. But there are certain aspects of control systems that can be discussed without resort to calculus and LaPlace transforms, and these aspects are the basis of troubleshooting and repair.

Control system basics

There are several different types of control systems, but we will consider two basic forms: *set-point control systems* and *servomechanisms*. One of the most common types of set-point control system is the ordinary furnace and thermostat in your home. Figure 1A shows the basic system and serves to illustrate the concepts. We have an *actuator* (in this case the furnace), a *sensor* (thermostat element) and a *controlled area* (the room).

The sensor in a home thermostat is a bimetallic strip that opens and closes as the temperature changes. Using the temperature setting knob, we can mechanically bias the strip to the temperature at which we want to keep the room.

When the temperature in the room is lower than the set point, the switch attached to the coiled sensor element is closed, so the furnace is turned on and heats the room. As the room heats up, the heat sensor element rolls back up and eventually opens the switch when the room temperature is above the set point.

Figure 1B shows the graph of temperature vs. time for a room controlled by the system of Figure 1A. Suppose the temperature is very cold in the room and you turn the thermostat to 65F. The furnace comes on, and the

temperature in the room starts to rise. The curve continues to rise until the actual temperature is a little above the set point, where the furnace turns off.

With the furnace off, the room temperature will begin to fall back toward the set point. At some temperature that is a little lower than the set point, the switch in the thermostat closes and turns the furnace back on, and the cycle repeats itself.

The characteristic of the system that causes the difference between the point where the furnace trips on and the point where it trips back off, is called the *hysteresis* of the system, and represents the damping factor of the system. A professor once likened this damping factor to "rust on the hinges" of a door swinging back and forth in the wind.

Furnace control

Control systems designers often use a diagram to help visualize the system. We can also use such a diagram in order to better understand the system. Figure 1C shows the control system diagram for the furnace controller of Figure 1A.

We have a set-point device (the setting device on the thermostat), a feedback sensor (also part of the thermostat) and a summing junction in which the input and feedback signals are compared. The output of the summer is a control signal that tells the actuator (furnace) what to do. In the case of thermostat system, the control signal is an ac voltage to the furnace ignition system, while in an analog control system, it might be a dc voltage that is proportional to

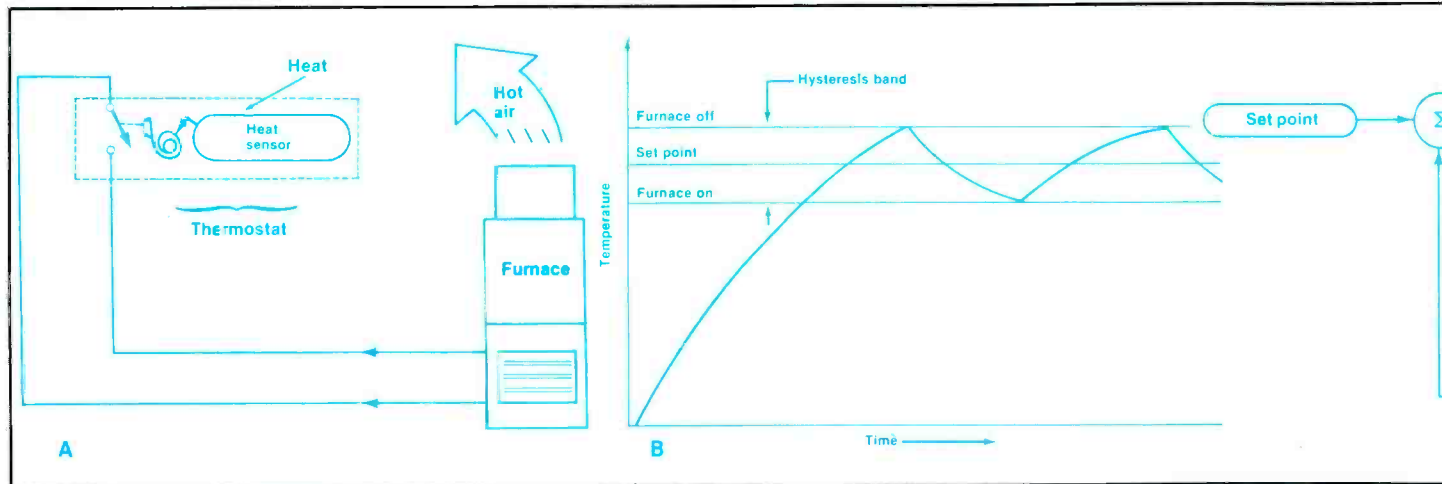

the error between the actual and set-point values.

The elements of this type of control system include a reference signal (set point), a feedback signal to represent the actual condition, a control signal to represent a difference between set and actual values, an actuator and a controlled area (or object, in other systems).

The diagram shown in Figure 1C may look familiar to most electronic technicians because it is similar to the block diagram for a feedback-controlled amplifier. Most hi-fi amplifiers are, in essence, control systems. Figure 2 shows the block diagram for a feedback amplifier. Note the elements common to the furnace control system: an input signal (set point), and amplifier (actuator), controlled area (output signal V_o), feedback system and a summing junction. In the case of the hi-fi amplifier, the summing point might be the emitter of an input state transistor, while in the heating system, it is the bimetallic strip of the thermostat.

Phase-locked loop

Figure 3 shows another circuit that is familiar to electronic technicians: the phase-locked loop (PLL). These circuits are also examples of control systems. Although the details differ, PLL control systems are found in FM and TV tuners, FM and stereo demodulators, and certain signaling applications in which the PLL is designed to recognize specific tones.

Figure 3 is the basic circuit for a PLL control system that is used to keep an oscillator on frequency.

The controlled object is a voltage-controlled oscillator (VCO) that operates on the frequency being generated. This type of oscillator produces an output frequency that is proportional to an input signal voltage. The summing junction in this case is an electronic phase detector. It compares the output of the frequency divider with the output of a reference oscillator, and produces an output that is proportional to the difference. In this case, the reference set point is a 10kHz crystal oscillator, while the other input frequency to the phase detector is a subharmonic of the VCO frequency. The division ratio of the frequency divider is used to bring the VCO frequency down to 10kHz. When the VCO is exactly on-frequency, the output of the divider is 10kHz.

The output of the phase detector will be either a dc error voltage that has an RF component, or a series of pulses with a width proportional to the error between F_o/N and F_1 . In both cases, the output is applied to a low-pass filter circuit. Some will tell you that the low-pass filter is used to get rid of the residual RF signal that survives the phase detector, but this is a simplification. The low-pass filter is actually a time-integrator circuit that is used to find the time average of the error signal. Because there is a time constant associated with integrator/low-pass filter circuit, this stage provides the rust for the PLL hinges. The output of the low-pass filter is a dc error voltage that is applied to the VCO control input.

A dc amplifier is used in some PLL circuits to scale the voltage to the level required by the VCO.

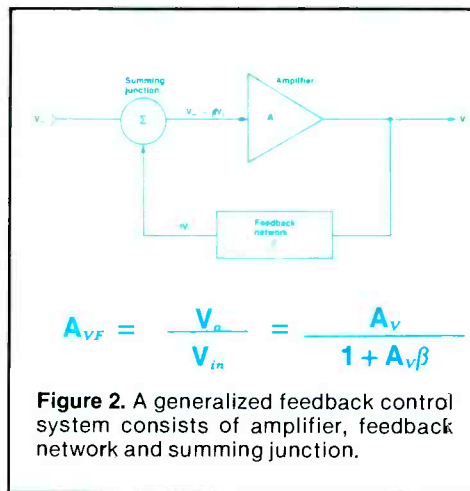

Figure 2. A generalized feedback control system consists of amplifier, feedback network and summing junction.

When the output of this amplifier is zero, the VCO will continue to idle at its natural frequency. But, if the frequency drifts, the phase detector produces an output, which in turn is reflected as a change in the output of the amplifier, which then pulls the VCO back on frequency.

Graph recorder

Another common device that illustrates the action of control systems is the graph recorder shown in Figure 4A. Although some readers are already familiar with this type of instrument, all should be able to easily see the action of the circuit and its relationship with the position of the pen on the paper. These recorders are sometimes called X-Y recorders, graph recorders, plotters or *servorecorders*. It is this last name that is most descriptive—because the recorder is an example of a *servomechanism*.

The block diagram for the servorecorder is shown in Figure 4B. The summing junction in this case is the input of a differential amplifier called a *servo amp*. The output potential E_o is used to drive the pen position motor and is proportional to the difference between a pen position signal and the input voltage. If there is a difference, it indicates that the pen is not at the position it should be to correctly indicate the input voltage.

The pen-position signal is derived from a transducer, or sensor. The sensor in this case is a potentiometer that produces a precise voltage that represents the pen position. If the reference voltage is +10V, then we could set up the

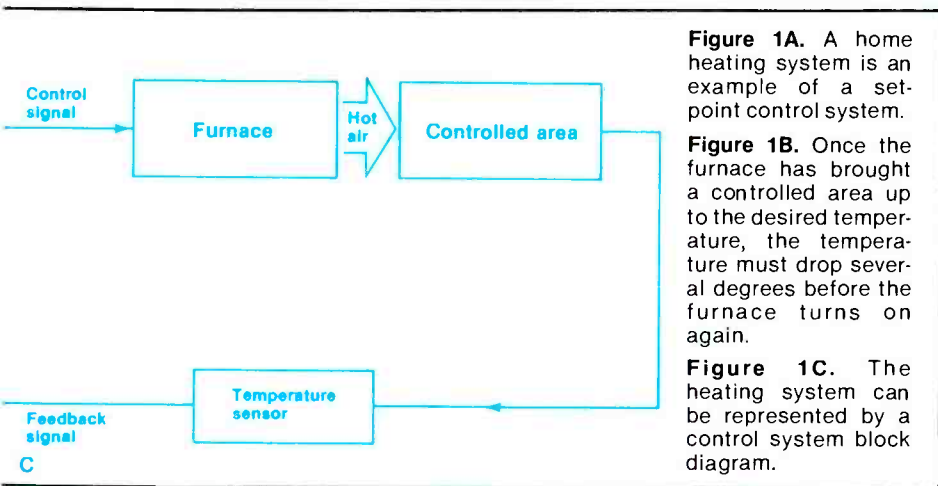

Figure 1A. A home heating system is an example of a set-point control system.

Figure 1B. Once the furnace has brought a controlled area up to the desired temperature, the temperature must drop several degrees before the furnace turns on again.

Figure 1C. The heating system can be represented by a control system block diagram.

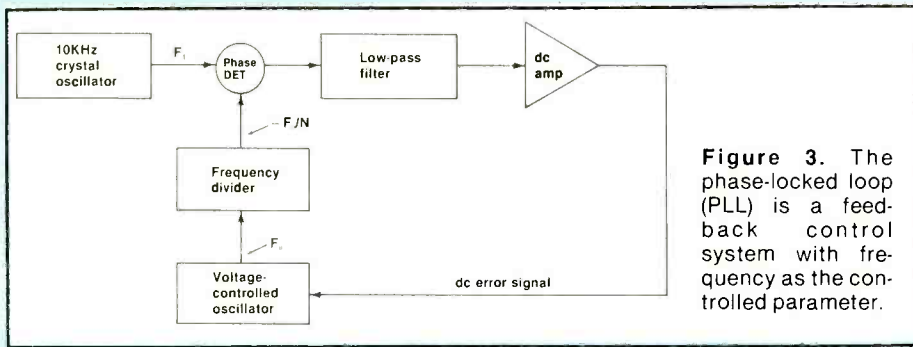

Figure 3. The phase-locked loop (PLL) is a feedback control system with frequency as the controlled parameter.

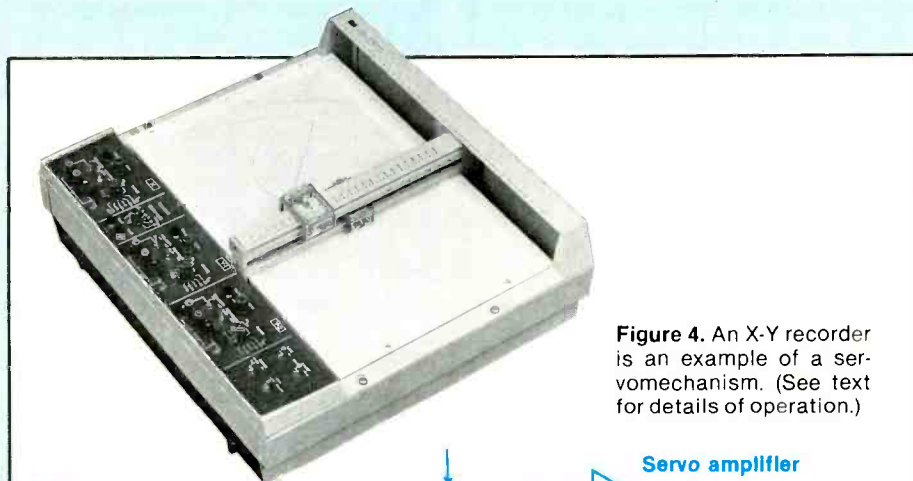
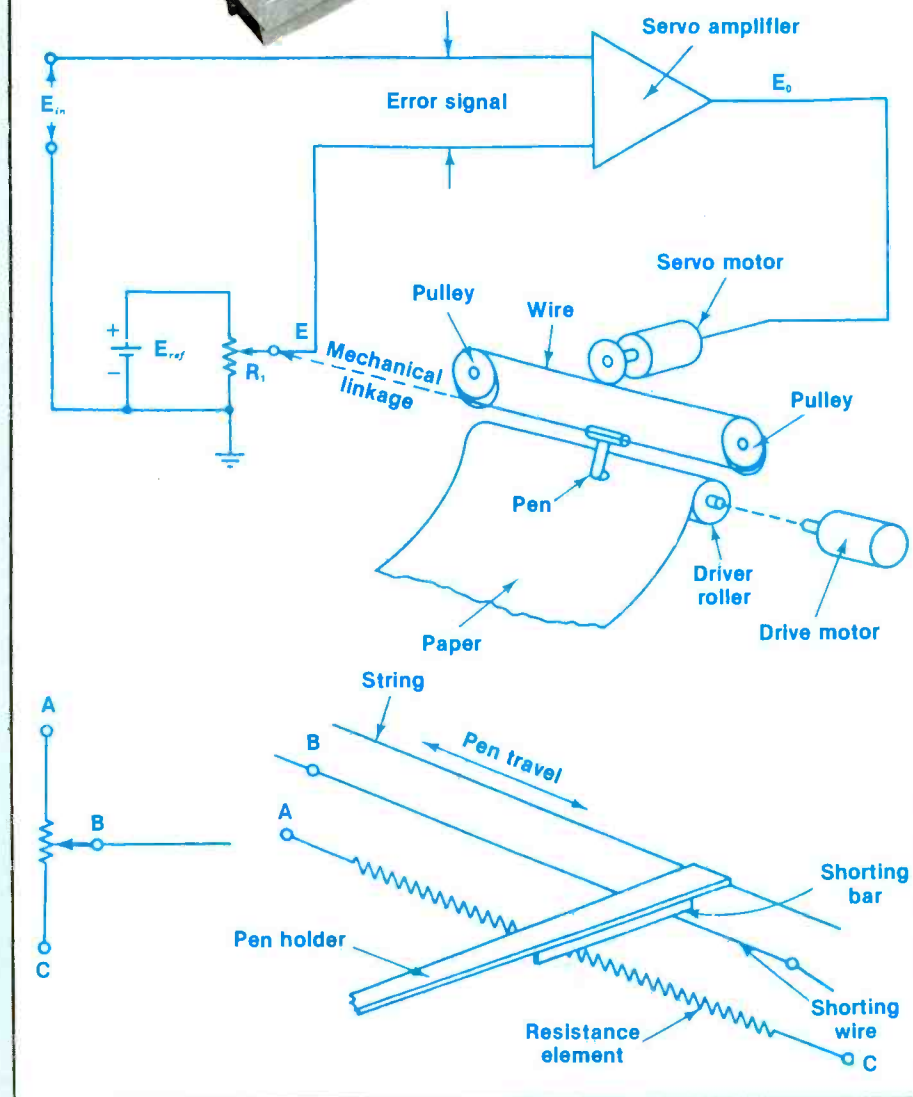

Figure 4. An X-Y recorder is an example of a servomechanism. (See text for details of operation.)



pen-position transducer potentiometer to produce 0V at the position chosen to indicate an input voltage of 0V, and 10V to indicate the position chosen for a full-scale input voltage. At positions in between these limits, the pen position voltage (E) will have an intermediate value.

Figure 4C shows the construction of one popular type of pen-position potentiometer. The pen holder travels on a string back and forth between the mechanical limits. It also rides on a resistance wire element that is parallel to the direction of travel. This element is the potentiometer. A shorting bar on the bottom of the pen holder shorts the resistance element to a shorting wire, which serves as the wiper terminal of the transducer. An ordinary potentiometer symbol is included to give you a frame of reference. Other servorecorders will use a precision rotary potentiometer and a gear box to translate the motion of the pen holder to rotary motion for the pot.

Control circuit problems

Control systems are capable of producing some of the most bizarre problems in electronic servicing, but that really should not surprise anyone who is familiar with troubleshooting electronic amplifiers.

Recall in the furnace controller illustration that we had a little bit of hysteresis between the set point and the points at which the actions of the system really took place. In servo systems, we call this same phenomenon the *deadband* of the system (Figure 5A). There is a little zone around zero at which the controlled object will not change, despite changes in the input signal. In the case of the servo recorder, the deadband is due to the inertia of the pen holder and pen drive system, and the friction of the pen drive system: It takes a certain minimum signal amplitude to overcome this inertia. The pen will slew through zero without being affected by the deadband, but will require a greater-than-normal signal when a voltage is applied from dead zero.

The deadband can be a cause of problems, either from being too small or too large. I recall servicing a piece of servo pumping equipment for a physiologist in a

medical school that had a greatly increased deadband. The pump seemed to respond much more slowly to changes than it had a few months before. The problem? In this case, it actually was rust. The pump was used to pressurize a line with physiological fluid (all of which are corrosive), and some had spilled into the pump motor/gear-box assembly and rusted some of the gear drive shafts. Removing the rust restored performance.

The matter of response of the system is shown in Figure 5B. There are basically three different levels of damping in a system. *Critical damping* means that the system responds in a minimum amount of time, and approaches the correct position or value from one direction without overshoot. A system with *overcritical* damping approaches the correct position from one direction and does not overshoot, but it takes too long to reach it. This system is sluggish compared with one that is *undercritically* damped. The undercritical system responds so rapidly that it overshoots the correct position and must reverse itself. It will

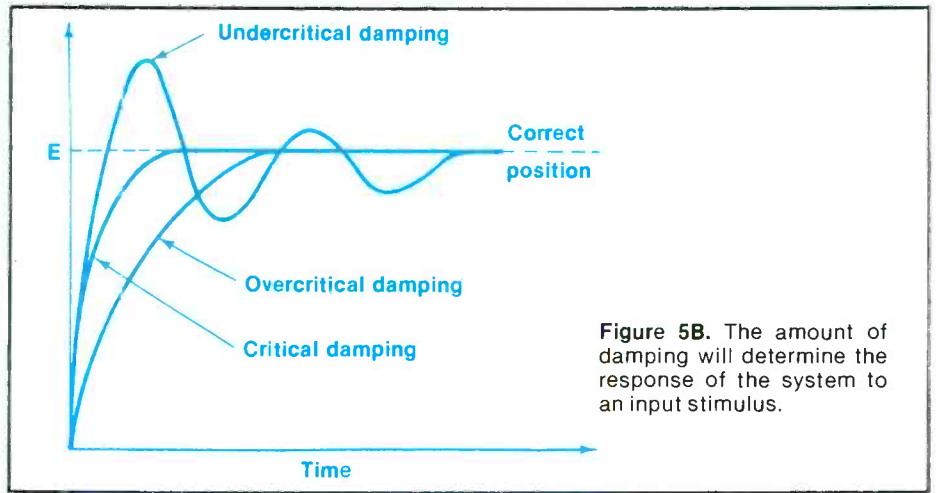

Figure 5B. The amount of damping will determine the response of the system to an input stimulus.

variable, then we can also vary the response time of the control system. In fact, in that servo pump I discussed above, one of my first jobs on the unit (which had been custom designed for the physiologist by an engineering firm) was to correct the frequency response of the system. It was too high, and as a result, the pressure in the fluid lines would overshoot the mark. The circuit used operational amplifiers, so it was a simple matter to connect a small-value

capacitor across the feedback resistor in order to make the circuit more sluggish (i.e. reduce its frequency response). The ideas of frequency response, damping and rust on the hinges are all inter-related and intertwined and become a focal point of design and troubleshooting problems in practical control systems.

Analog circuit elements

Most analog control systems made today use operational amplifiers. In fact, many of the

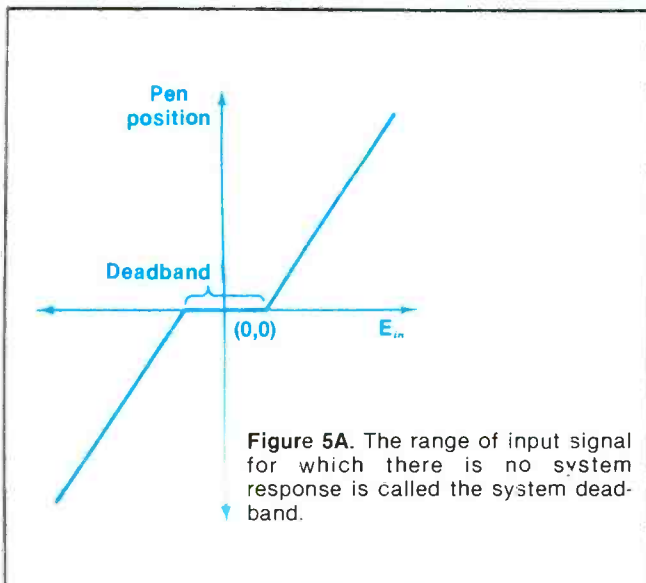

Figure 5A. The range of input signal for which there is no system response is called the system deadband.

hunt around the correct position until it finally comes to rest at the correct spot. The undercritically damped waveform looks very much like the waveform of a shock-excited LC tank circuit.

The damping factor is also expressed in terms of the frequency response of the system. If the frequency response of amplifiers is

OPTIMA ELECTRONICS
TO ORDER CALL TOLL FREE 1-800-327-0224
G.E., SYLVANIA, ZENITH, RCA, 75% OFF LIST NEW-BOXED

<input type="checkbox"/> 3A3	5 FOR \$15.75	<input type="checkbox"/> 6LF6	5 FOR \$34.44
<input type="checkbox"/> 6MJ6	5 FOR \$34.88	<input type="checkbox"/> 6LB6	5 FOR \$31.50
<input type="checkbox"/> 6JE6	5 FOR \$32.75	<input type="checkbox"/> 6CJ3	5 FOR \$14.69
<input type="checkbox"/> 3DJ3	5 FOR \$17.44	<input type="checkbox"/> 6JS6	5 FOR \$29.00
<input type="checkbox"/> 6GH8	5 FOR \$12.44	<input type="checkbox"/> 6BL8	5 FOR \$12.25

All Tubes Not Advertised, Write in at 75% Off List.
Sleeves Only, Singles 72% Off List

HORIZONTAL OUTPUT TRANSISTORS **ECG REPLACEMENT TRIPLERS**
\$1.95 ea. Min. 10, 2 yr. Warranty

<input type="checkbox"/> RKS1172B	<input type="checkbox"/> RKS238	<input type="checkbox"/> 500A	\$11.50	<input type="checkbox"/> 523	\$13.50
<input type="checkbox"/> RKS1308K	<input type="checkbox"/> RKS165	<input type="checkbox"/> 522	\$11.50	<input type="checkbox"/> 526A	\$14.95

TRANSISTORS & I.C.'s...MIN. 10, CAN MIX

T.V. #'s	Pop. I.C. #'s	STEREO #'s
<input type="checkbox"/> 2SC1114	<input type="checkbox"/> 712	<input type="checkbox"/> DM133
<input type="checkbox"/> MN8303	<input type="checkbox"/> 713	<input type="checkbox"/> DA101
<input type="checkbox"/> 2SC1034	<input type="checkbox"/> 714	<input type="checkbox"/> HA1377A
<input type="checkbox"/> 2SC867A	<input type="checkbox"/> 731	<input type="checkbox"/> HA1388
<input type="checkbox"/> 2SD870	<input type="checkbox"/> 790	<input type="checkbox"/> HA1396
<input type="checkbox"/> 2SD871	<input type="checkbox"/> 791	<input type="checkbox"/> HA1398
<input type="checkbox"/> AN5210	<input type="checkbox"/> 792	<input type="checkbox"/> UPC1181
<input type="checkbox"/> AN5310	<input type="checkbox"/> 793	<input type="checkbox"/> UPC1182
<input type="checkbox"/> AN5320	<input type="checkbox"/> 819	<input type="checkbox"/> UPC1185H
<input type="checkbox"/> AN5435	<input type="checkbox"/> 820	<input type="checkbox"/> 2SA1105
<input type="checkbox"/> 2N3055	<input type="checkbox"/> 848	<input type="checkbox"/> 2SC2580

GENERAL

<input type="checkbox"/> 1308K Sanyo	10 for \$22.50
<input type="checkbox"/> 2.5 Amp. 1000 PIV Rect.	100 for \$ 8.75
<input type="checkbox"/> VEH0070 Video Head (4 hrs.)	\$49.95
<input type="checkbox"/> ADC MARK III CARTRIDGE w/needle, Min. 2	\$6.95
<input type="checkbox"/> 6 ft. Cheater Cords SPT2	10 for \$ 7.95
(Heavy Duty - UL App. 7 Amp. 125V. P & NP)	
<input type="checkbox"/> 800-860 Zenith Safety Cap	\$ 3.95
<input type="checkbox"/> Pop. Mag. Safety Caps 250663-11-17-19	\$ 3.95
<input type="checkbox"/> Pop. GE Caps 25x60-75-78-79	\$ 3.95
<input type="checkbox"/> ZEN. Mod. 9-103-04	\$ 8.95
<input type="checkbox"/> AN16 Trinitron Dual Ant. for Sony, Min. 2	\$ 6.95
<input type="checkbox"/> 15 ft. Head Phone Ext.	10 for \$4.90

Quantity Prices Available

Letters of credit and all checks placed on deposit with Bank of Hallendale, FL. VISA & Master Charge accepted. Min. order \$75. FOB Dania, FL. Catalog \$3, refundable upon order.

SEND CHECK OR MONEY ORDER TO:
OPTIMA ELECTRONICS
2022 Tigertail Blvd., Dania, FL 33004
Phone (305) 920-3550 TOLL FREE: 1-800-327-0224

Circle (20) on Reply Card

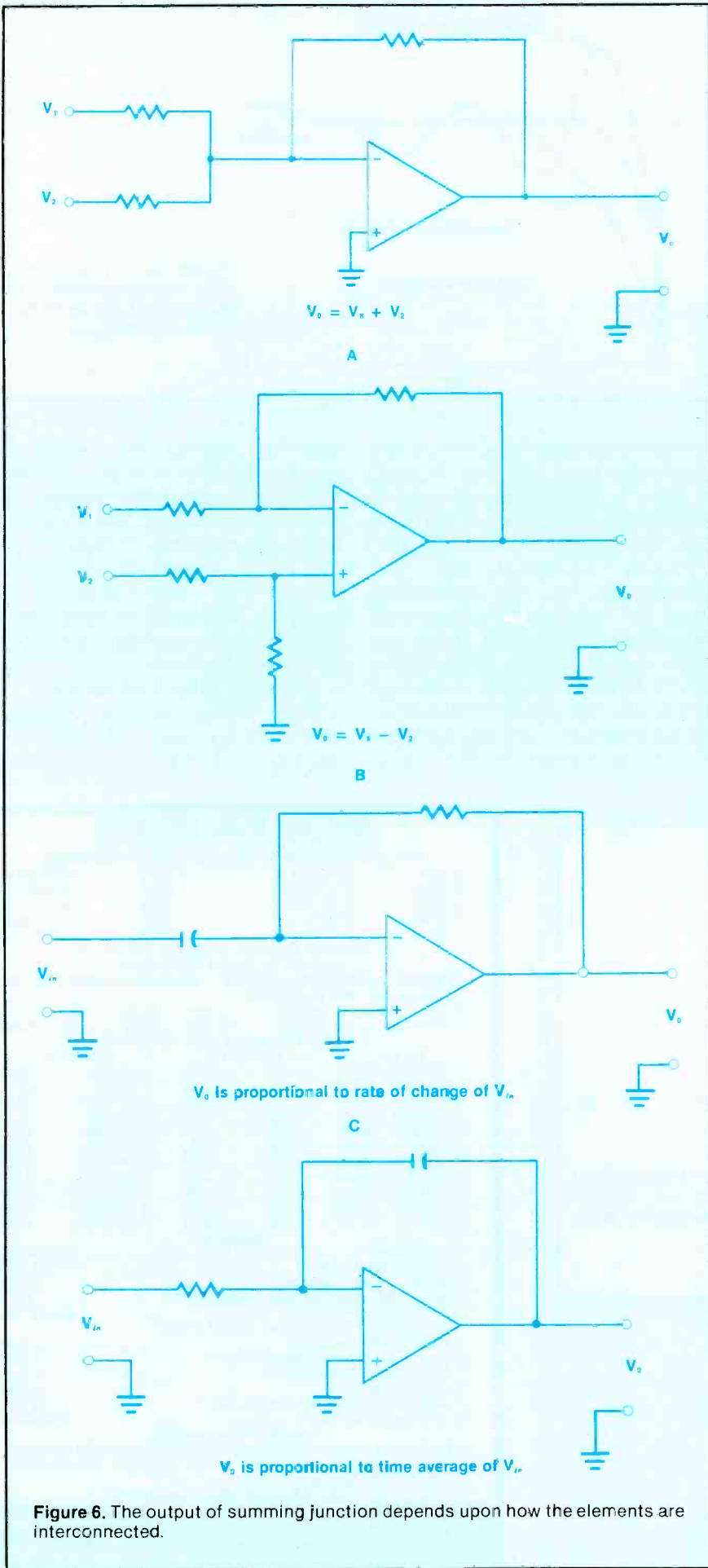

non-IC control-system electronics packages still in use basically use discrete versions of the op-amp. If all we need is gain, then the straight inverting and non-inverting amplifier configurations are used. But control systems are often dynamic circuits and require almost the entire range of circuits possible with operational amplifiers. In fact, one author once called the control systems an analog computer with an actuator for the output and sensors for the input. We find all of the common op-amp configurations in control system electronics, including inverting amplifiers, non-inverting amplifiers, logarithmic amplifiers, antilog amplifiers, differentiators, integrators, bounded value amplifiers and so forth. Almost any good book on operational amplifier circuitry will cover these in detail.

Figure 6 shows some of the most common circuit configurations. The circuit in Figures 6A and 6B are used in summing junctions, depending upon whether you need the sum of two voltages (Figure 6A), or the difference between two voltages (Figure 6B). We also pro-

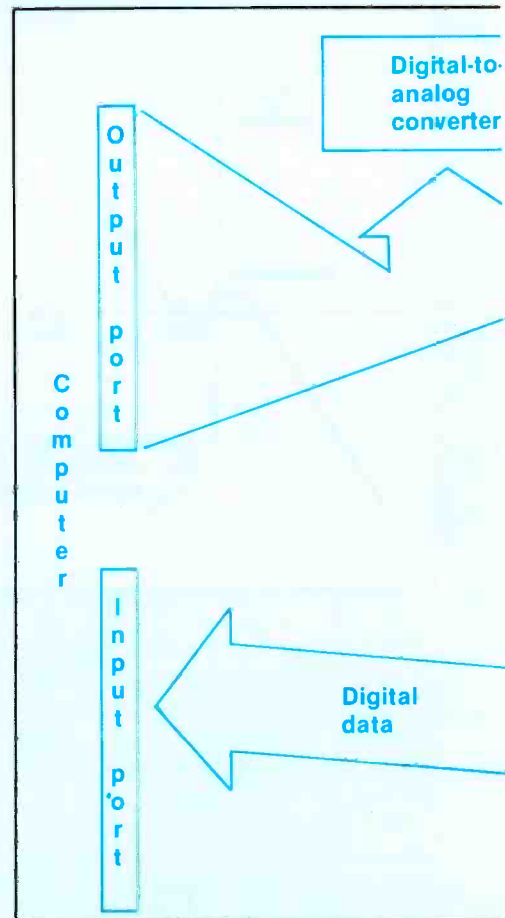

vide a certain amount of gain if the correct resistor values are selected (gain of unity if all resistors have the same value).

The differentiator circuit is shown in Figure 6C. This op-amp circuit produces an output signal that is proportional to the *rate of change* of the input signal. The differentiator signal is used in cases where it is important to make the response different for higher rates of change.

In the example of our servorecorder, for example, differentiators are sometimes used in the pen protection circuit. The pen position signal is fed also to the input of the differentiator. If the output of the differentiator indicates that it is traveling too fast, which means that it may be destroyed as it slams against the high-end stop, a correction can be created to slow it down. Some circuits crank in the differentiator output, summing it with pen position signal *E* in reverse polarity if the rate of change is too high. This counter potential tends to slow down the system.

The integrator circuit of Figure 6D is the opposite of the differen-

tiator (note the reversed roles of *R* and *C*) and creates an output voltage that is proportional to the time average of the input signal. This circuit is also called a low-pass filter and is used in many cases to provide controlled damping for the system.

Digital control systems

We are in the age of the electronic digital computer. In the recent past, it was too expensive to use computers in all but the most expensive of control systems. Some factories used minicomputers to control automated assembly line processes. But, with the microcomputers that are available today, electronic digital control systems are used in an increasing variety of control applications. It has been said that an engineer who is not capable of working with/on microprocessors and microcomputers will be all but unemployable in a few years, and the same may be also true of service technicians. Where service work in many of our traditional markets is falling off—for a variety of reasons—work in the digital sector is increasing dramatically.

There are several ways to create digital control systems using a microcomputer, but we will consider only those that operate through input/output (I/O) ports. Input ports can be used to receive digitized data from the outside world, while output ports are used to send data to the outside world. Consider Figure 7.

The system shown in Figure 7 is a trivial case used to illustrate the basic concepts. We are trying to lift a weight *L* from zero to height *h*. A linear potentiometer is used as a position transducer, as in the servorecorder discussed earlier. The weight is lifted by a rope that is connected to the pulley of a motor-driven winch. The speed of the motor is determined by the voltage at the output of an amplifier and digital-to-analog converter system. The DAC takes an *n*-bit binary word from the output port of the computer, and converts it into a voltage level that is proportional to the binary word.

The weight position signal (V_p) is applied to the input of an analog-to-digital converter (A/D) that produces a digital output word that is proportional to the value of the voltage V_p .

The computer compares the actual position, as read from the input port, with the position stored in computer memory as the correct position, and then generates whatever output signal is needed to correct the error, if any. The programming of the computer can be used to replace the electronic circuitry of the analog controller, and much of the logic used in non-computerized digital controllers.

Why would anyone want to make a computer control system when all we need are a few operational amplifiers to make the thing work? Because the control system that uses a computer can often be modified merely by changing the *programming* of the computer. In addition, the digital circuitry is more able to adapt to numerical control and does not drift as do analog circuits.

Control systems are a challenging troubleshooting experience and a profitable one to the technician who understands them. This limited article cannot do justice to the subject, but serves to introduce you to the basic concepts.

ES&T

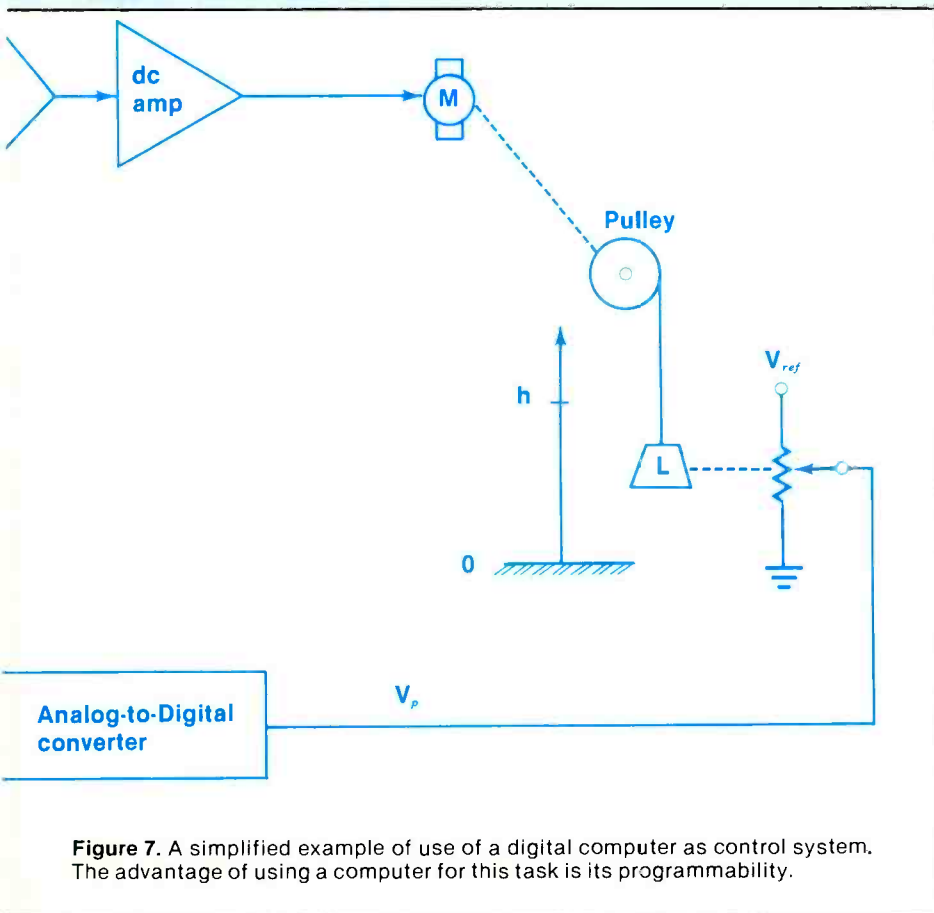

Figure 7. A simplified example of use of a digital computer as control system. The advantage of using a computer for this task is its programmability.

An ES&T how-to special:

Servicing Atari video games

I've been servicing the Atari VCS* (Video Computer Systems*) since the company established its ISC (Independent Service Center) network in January 1982. This article is based on that experience.

Easy to fix

You won't need much digital theory to service video games. Most of the work involves replacing obviously defective parts, such as sockets and switches. Electronic troubles are usually cured by a swap-out procedure similar to that used with tube-type televisions. The circuit board is silk-screened with reference numbers, and most parts are easily accessible. The only subjects you might have to brush up on are soldering techniques for double-sided boards and proper handling of static-sensitive ICs.

You'll notice I have not included a complete schematic, in accordance with Atari's policy, but you won't need it. The information in the partial diagrams, and most

*Atari
trademark

By Kirk Vistain

important, the interconnection charts, are all I have ever needed to effect a repair. Of course, ISCs receive a wealth of information from Atari, so you might want to apply for authorization.

The LSI (Large Scale Integration) digital design of these games makes for simple troubleshooting; most of the circuit complexity is within the ICs. If the output is not what it should be, you simply test the input. If the input is right, the chip is bad. If the input to the IC is not correct, trace back until you find where the input signal is lost. To make things even simpler, the input is one of only two possible states: *on* or *off*. (Also referred to as 1 or 0, high or low.) There's little of the uncertainty as to amplitude or waveshape that plagues analog repair.

We can't possibly cover everything in one article; the Atari service manual itself is as thick as this magazine. But the charts and diagrams presented here should go

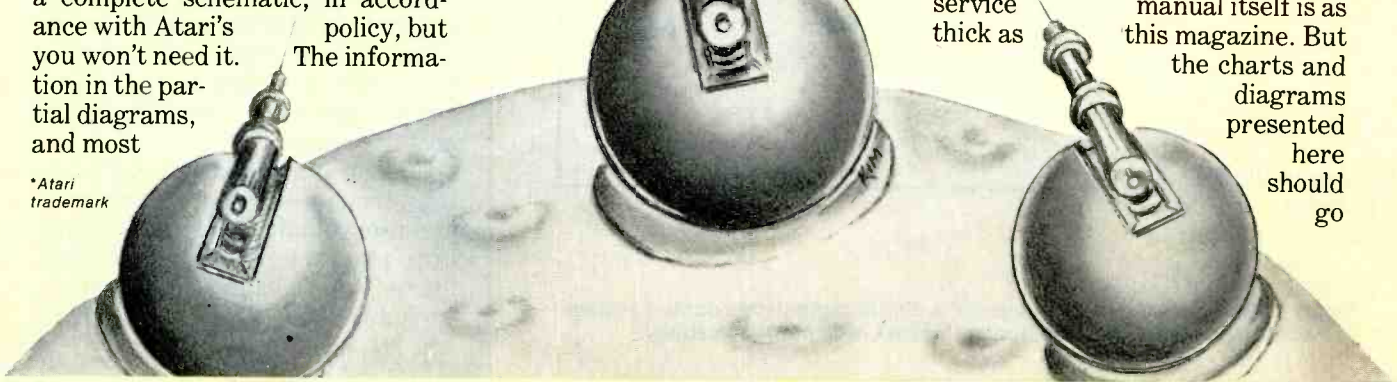

a long way in helping you understand how to service these units.

Tools and equipment

Other than what is normally found on an audio or video test bench, only a few special tools are required.

- color TV receiver
- ad adapter (Atari CA014034 or other 9 to 12Vdc supply)
- pair of XY (joystick) controllers (Atari CA012994-03)
- one paddle controller set (Atari CA012760-06)
- one game program for each type of controller (I use Missile Command and Video Olympics)
- chip puller (Xcelite XD16 or equivalent)

Atari's test routine cartridge is not absolutely necessary, but it is convenient. However, you'll still need the actual game cartridges for some tests.

Technical description

There are two versions of the VDS: the CX2600 and the CX2600A, which we'll refer to as "A." The circuitry is almost identical, but some part numbers have been changed and some parts deleted. The CX2600 has two circuit boards connected by a 12-conductor cable. The *switchboard*, a single-sided PC board, contains the power-supply regulator, the RF modulator and the console switches. The *motherboard*, a double-sided PC board enclosed in a cast-aluminum shield, contains the bulk of the circuitry.

The updated model, the A, eliminates the switchboard, moving all components to the motherboard. This necessitated relocating the Difficulty switches toward the rear of the unit.

The CX2600 has six chrome-handled switches in line with the cartridge socket, while the A has only four. A different clock crystal is used, as well as a new sound coil.

The A also dispenses with the hex buffer IC, one of the clock transistors and some associated parts. A sheet-metal shield replaces the cast housing.

Figure 1 shows a block diagram of the CX2600A that also applies to the CX2600, taking into account the aforementioned differences. The Random Access/Input-Output (RAM/IO) IC is a 40-pin LSI

device, which scans the console switches and the XY controller lines. It generates a programmed output to the Television Interface Adaptor (TIA) and Microprocessor Unit (MPU) when it senses closure. Also it stores rules from the game cartridge Read Only Memory (ROM) during play, and keeps track of time and score.

The TIA is a custom 40-pin IC. Its primary purpose is to convert the digital information from the RAM/IO and MPU into standard TV video and audio. It also digitizes analog information from the paddle control lines, conditions the trigger signal from the joystick firing button and processes the clock output into a 2-phase signal. All operations take place under the control of the MPU, a 28-pin 6507 IC, which coordinates data transfer.

Both versions of the game use discrete technology for the sound and clock oscillators. The A has a single-transistor, crystal-controlled clock, while the CX2600 uses a multivibrator configuration. The sound carrier is generated by an LC oscillator in both (Figure 2).

outboard switch. It is replaced as an assembly if it fails.

Operating power is provided by a 5V regulator IC in a TO 220 package. The regulator is fed by a wall-mounted ac adaptor, which produces a 9Vdc output.

Although several different controllers are available, only two are in common use. One is the familiar joystick or XY controller, which contains five NO switches. Four sense the direction in which the stick is pushed—right, left, up and down—and one is the firing or trigger switch. If the stick is pushed both up and right, for example, two switches will close. The computer translates this to diagonal movement (depending, of course, on the game in play). The same is true of other combinations of direction. The controller cable ends in a 9-pin plug that fits into one of the two input ports (J202, J203) on the back of the VCS.

The paddle controller consists of a potentiometer and a switch. The pot is connected from Vcc to ground. The TIA senses the voltage on the center slider of the pot and converts this to positional

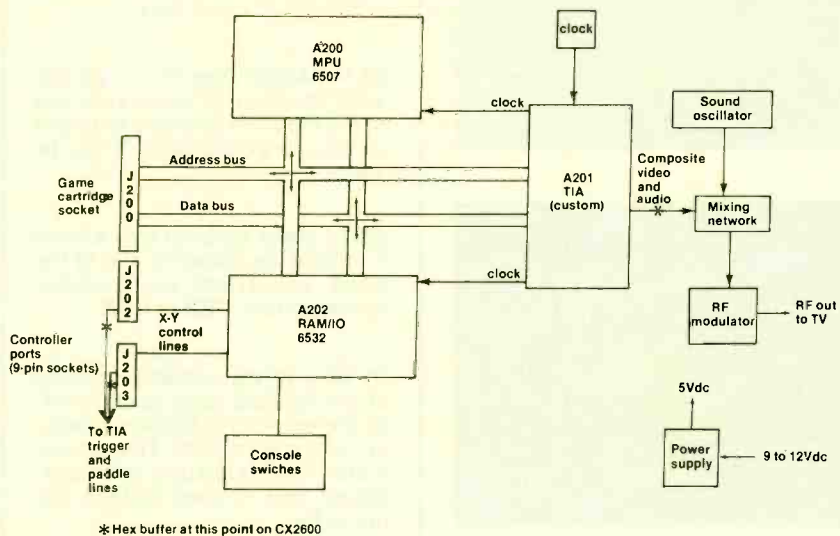

Figure 1. The use of LSI integrated circuits makes troubleshooting of video games less formidable than it might first appear. This is a block diagram of the Atari CX2600A.

The hex buffer used in the CX2600, a standard 4050 CMOS, IC, interfaces the trigger and luminance lines with the TIA. The A does without it.

The RF modulator takes the composite video and audio from the TIA and converts it to a Channel 2 or 3 output, selected by an

information for the game in play. The analog output of the paddle must first be processed through the TIA in order to be digitized. The switch is handled by the RAM/IO similar to the manner in which the joystick switches are handled.

Paddles come in pairs. One pair

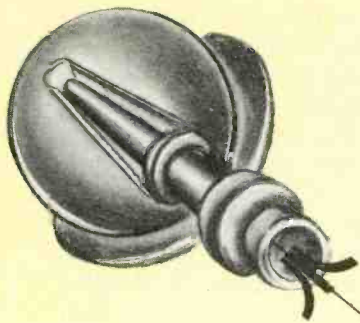

4B

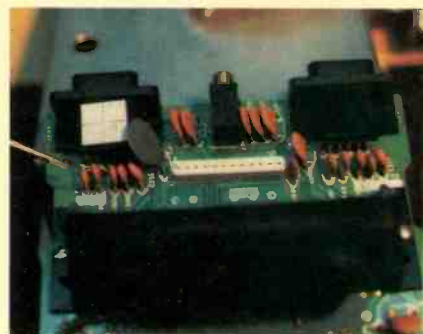

5



1

(1) The Atari VCS is available in two models. The CX2600 (bottom) employs two circuit boards; the CX2600A (top) uses only one.

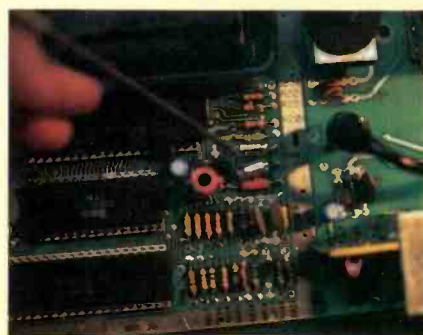

6

(2) In the CX2600A, the switch-board has been eliminated, and all components are on one board.

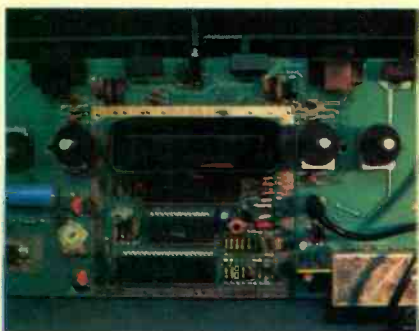

2

(3) Replacement of the TIA, MPU or any clock parts often requires re-adjustment of the Color Delay pot. This is the only variable resistor in the unit.

(4) Any CX2600A brought in for service should be modified by replacing C241 (A) and C242 (B) with 0.1mF/50Vdc capacitors.



7

(5) If RAM/IO pins fail to go low when the joystick is operated, one of the input-pin bypass capacitors (shown here on a CX2600) may be leaky.

(6) An audio problem may almost invariably be traced to one of the 820pF, polystyrene, sound oscillator capacitors, C206 or C207.



3

(7) Most of the complex circuitry of the CX2600 video game units, as shown here, is contained within the ICs: RAM, CPU, TIA and hex buffer. The CX2600A is the same, except that it does without the hex buffer.



8

(8) The clock crystal provides the precise signals needed to synchronize the operation of the system.



4A

(9) White arrows point to important contact areas for the shield grounds on the CX2600.



9

plugs into each port. A total of four players is therefore possible with paddle games, whereas only two may be accommodated in joystick-controlled games.

Basic troubleshooting

A recommended first step in troubleshooting a video game is to verify a customer's complaint when he first brings a unit in for repair. It's a good idea to test the device with the customer's accessories, especially when the complaint is "dead" or "one controller inoperative." If an ac adapter or a controller is bad, they should be replaced because these are not worth repairing.

In cases in which you have isolated the problem to the console itself, you'll probably find it best to follow a routine similar to this:

- Make a thorough operation check with known-good accessories. Actually try to play a game. Work all the switches; they should feel smooth and should not bind. *Reset*, *Game Select* and *Power* switches often fail because they're used the most.

Wiggle all the connectors and bang on the unit a little. Watch for changes in the picture or other symptoms, such as spurious reset or game selection.

This is the first stage of troubleshooting any equipment. Careful observation at this point can save time later and may warn you of secondary trouble the customer missed.

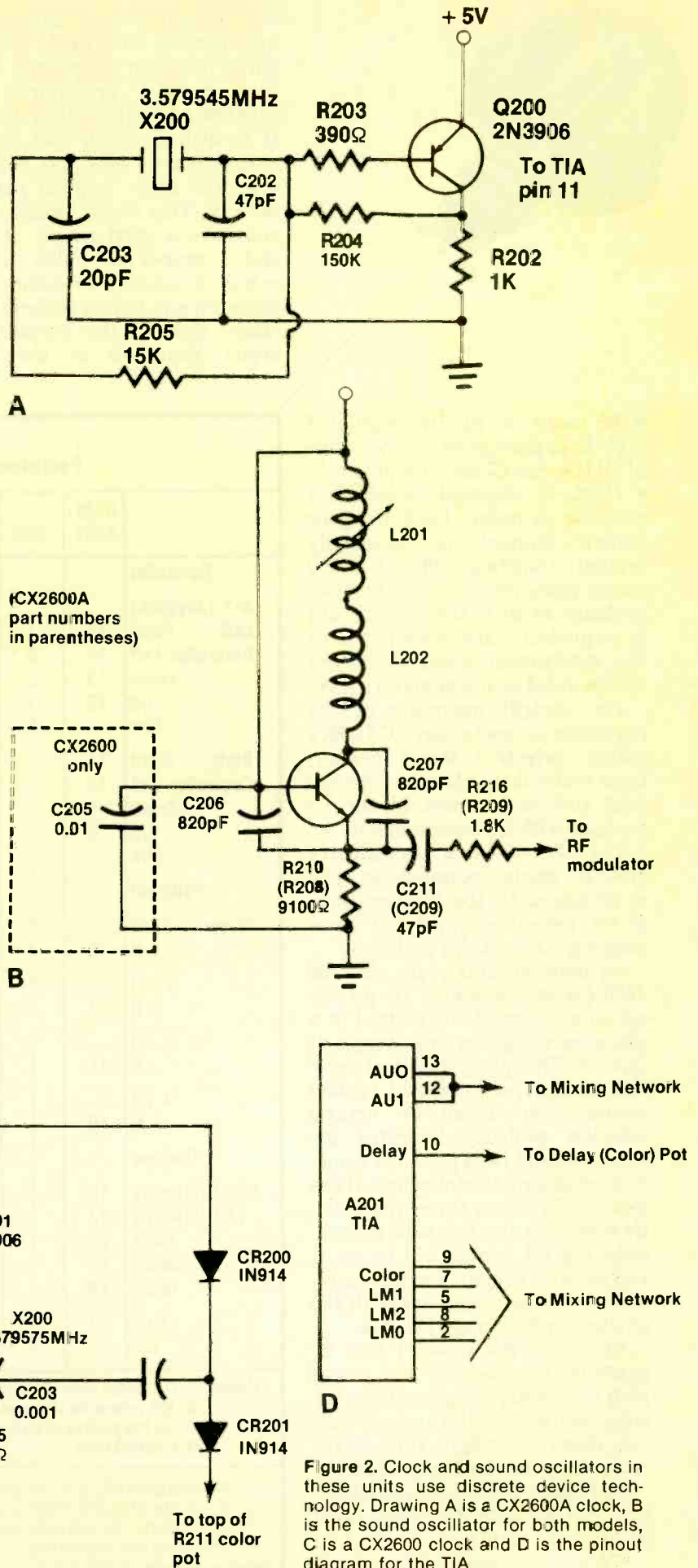
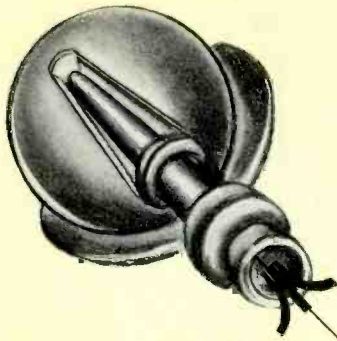

Figure 2. Clock and sound oscillators in these units use discrete device technology. Drawing A is a CX2600A clock, B is the sound oscillator for both models, C is a CX2600 clock and D is the pinout diagram for the TIA.



haven't found the cause of the malfunction, it's time to swap-out parts, based on symptoms. Atari's recommended procedure is to substitute ICs until the unit works. It is then assumed that the last part replaced was the defective one. The other original parts go back in. This works pretty well if you have a good supply of parts and a proper IC puller. It also makes it possible to assign video game repairs to less skilled technicians. Most of the troubles that aren't identified in the initial

checkout are caused by malfunction in one of the ICs.

It is desirable to develop an understanding of common symptoms that are ordinarily associated with each chip or other component, so you can save time by first replacing the part that is most likely to be at fault.) A quick reference can be found in Chart 2, which matches component failures with symptoms and lists the most likely cause first. This chart is based on actual field repairs and assumes that you have already pursued

- Be sure a tightly regulated +5Vdc is present at the Vcc pins of all ICs. See Chart 1 for pinout.

- Next, a thorough mechanical check is in order. Look for poor solder connections, especially around switches. The CX2600 seems more prone to this trouble, probably because the switchboard is single-sided and does not have the mechanical strength of the double-sided connections on the A.

The upright mounting of the regulator on some early CX2600s makes defective solder connections more likely. Also be sure the heat sink is fastened to the IC package with a Tinnerman nut.

The CX2600 has a 12-conductor ribbon cable connecting the switchboard to the motherboard. If it's defective, you'll get some puzzling intermittent problems.

On units several years old, the J200 (cartridge) socket frequently exhibits intermittent faults. Put a game cartridge in and wiggle it around. The picture (if you have one at this point) should remain stable. Any noise or erratic behavior probably indicates the socket should be replaced. I usually do it as a matter of course if the unit is more than three years old. Be gentle during this test, though; even a good socket will let go if you're too rough. Furthermore, pulling the cartridge out with the power on will damage the ICs.

Test the J204 (power) jack by grasping the body of the power plug and gently wiggling it in a circular motion. If the picture cuts out, check the solder connections. If they're good, replace the jack.

Bad solder around the modulator pins and RF output jack can cause snowy or no picture.

If you get to this point and still

Chart 1
Peripheral - IC pin interconnects

	RAM A202	J202	J203	TIA A201	Bypass Capacitors	MPU A200	Buffer ³ A203
Controller					2600 2600A		
X-Y (Joystick)							
Left							
Right	15	4			C235 C230		
Controller							
Left	14	3			C234 C229		
Down	13	2			C233 C228		
Up	12	1			C232 C227		
Fire	6		14 ¹	C236 C217		9
Right							
Right	11		4		C231 C226		
Controller							
Left	10		3		C230 C225		
Down	9		2		C229 C224		
Up	8		1		C228 C223		
Fire		6	15 ¹	C237 C216		7
Paddles²							
Player							
1 VR	5		40	C215 C218		
B	15	4					
2 VR	9		39	C216 C219		
B	14	3					
3 VR		5	38	C217 C220		
B	11		4				
4 VR		9	37	C218 C221		
B	10		3				
Console							
Right Difficulty	16				C231 C223		
Left Difficulty	17				C232 C224		
Color	21				C233 C225		
Select	23				C234 C226		
Reset	24				C235 C227		
Gnd	1	8	8	1		2	8
Vcc	20	7	7	20		4	1

Notes: 1. CX2600A only. Fire lines go through buffer on CX2600.
2. VR refers to the analog output (a variable resistor). B refers to the pushbutton output.
3. CX2600 only

Troubleshooting a video game is facilitated by a knowledge of how the elements of the system are interconnected. This chart shows how the controllers, the console switches, power supply and ground are connected to the internal circuitry.

basic troubleshooting methods. Component failures other than those listed could cause similar symptoms, but rarely do.

In the following discussion, I will often refer to an IC pin as being H (high) or L (low). An H should measure around 4.8Vdc to ground. An L is at ground potential.

Most of the RAM/IO and TIA controller lines are "active low." This means they respond when taken to ground. When not activated, they should measure H. You can often simulate switch

closure by grounding the appropriate IC pin with a jumper.

Video symptoms

When a gray screen (carrier present, no modulation) is the complaint, the most likely culprit is the clock. Look for a 4-to-5 VP-P waveform on pin 39 of A202 (RAM/IO). If it's not there, 'scope the clock output. In the case of the CX2600 this is the R204/C203 intersection. The collector of Q200 is the test point for the clock output of the A. If no waveform is pres-

ent, the clock circuitry is probably bad. If the clock output is good, follow the signal until you find where it disappears. It is processed through the TIA (in on pin 11 and out at pin 26), then goes to MPU pin 28 and RAM pin 39.

Replacement of the TIA, MPU or any clock parts often requires readjustment of the COLOR DELAY pot. This is the only variable resistor in the unit. If you're using a regular game cartridge, adjust for normal colors. If a diagnostic cartridge is available, adjust for a color match between the bars above and below the gray reference bar.

A common symptom in As is color washout with wavy lines in the background, caused by poor power supply decoupling. This fault can be cured by replacing C241 and C242 with 0.1mF/50Vdc units. Every A you service should be thus modified unless it already has the proper capacitors.

Many video failures are intermittent. Sometimes an hour or more of use is necessary before the problem occurs, so don't be fooled. Atari recommends a 2-hour burn test for every unit after repair. Though a good idea, this may be impractical if your volume is large. After a while, your experience will tell you when it's necessary.

Controller problems

Control function failures constitute the second most common class of trouble. Always check the 9-pin sockets first. Broken, bent or worn pins are often the cause of problems.

On the CX2600, the usual complaint is "fire button inoperative" or "fires continuously." I've seen so many of these that I just automatically change the hex buffer, A203, but it's best to check first. Use a DVM to ensure that the hex buffer input pins 7 (for the right-hand control) and 9 (for the left-hand control) are H until the firing button is depressed. Then, either pin should read low. If no change is observed, follow the conductors back to the input ports. Look for a break in the foil. Theoretically, a defective TIA could cause the same symptoms, but this is rare.

The A doesn't usually have firing button trouble, but when it does, a bad J202 or J203 is common.

Chart 2

Symptom	Cause
1. Gray screen, no modulation	Clock, RAM, J200, MPU, TIA, 12-pin cable (2600)
2. X or other diagonal pattern with diagnostic cartridge.	RAM, MPU, J200
3. Distorted picture, missing picture elements	RAM, TIA
4. Jitter, loss of sync	TIA, RAM, J200
5. Spurious vertical lines	TIA
6. Color washout, wavy lines	Endemic to A. Replace C241, C242 with 50V units
7. No or distorted audio	C206, C207
8. Continuous or no firing	Hex buffer, J202, J203
9. Console switch inoperative	Switch bypass capacitor, RAM
10. Loss of movement in one or more directions	J202, J203, bypass capacitor, RAM
11. Paddle lines inoperative	TIA
12. Snowy picture	RF cable

Notes: 1. Causes listed left to right in descending order of frequency, based on personal experience.
 2. It is assumed that all accessories are OK.
 3. It is assumed that basic troubleshooting procedures have been followed first.

These VCS troubleshooting symptoms and causes can be used to isolate faulty components.

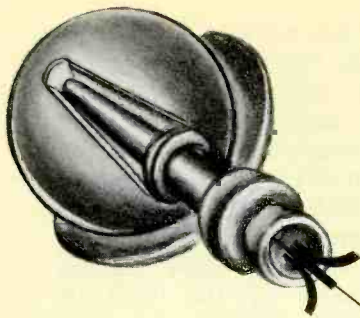

Sometimes the pins break off at the back of the socket where they enter the plastic. They look OK, but you can find the bad one by poking around with a diddle stick or desoldering until you find a loose one.

Failure of a joystick to cause motion in one or more directions could be the result of a bad RAM/IO. Measure the IC pins to see if the appropriate ones go to ground when the controller is operated. Refer to Chart 1 for a summary of pin functions. If the pin always measures H, a connection is broken between the input jack and the IC. If it is always low, the RAM/IO may be bad, or one of the associated bypass capacitors may be leaky. Chart 1 shows which capacitors are associated with which pins. Follow the same procedure if a console switch is inoperative or if the unit appears to be stuck in a mode, such as *Reset* or *b&w*.

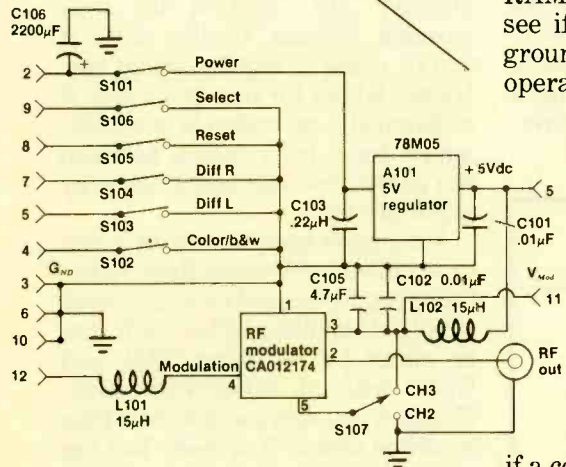

In this block diagram of CX2600 switch board, connector pin callouts refer to J101.

Chart 3

J200	MPU	RAM	TIA
1	12	36	21
2	11	40	-
3	10	2	27
4	9	3	28
5	8	4	29
6	7	5	30
7	6	6	31
8	5	7	32
9	25	33	14
10	24	32	15
11	23	31	16
12	-	-	-
13	22	30	17
14	21	29	18
15	20	28	19
16	19	27	33
17	18	26	34
18	17	-	-
19	15	-	-
20	16	-	-
21	14	-	-
22	13	-	-
23	-	-	-
24	2	1	1

The cartridge socket (J200) is connected to the MPU, RAM and TIA. This chart lists those connections.

Paddle line test

If paddle movement is incorrect, a paddle line test with an oscilloscope is in order. Set the scope vertical sensitivity for 1V/div., and sweep for 2ms/div. Check TIA pins 37 through 40 for a rounded sawtooth waveform, approximately 4VP-P. If the waveform is OK, the IC is probably bad. If the waveform is absent, follow the circuit traces back to the controller socket, looking for breaks.

Audio

Audio troubles are rare. The cause is almost always the two 820pF polystyrene sound oscillator capacitors, C206 and C207. Press gently on one or both of them. If this causes the trouble to come and go, this is a sure sign they should be replaced. Afterward, readjust the sound coil (L201) if necessary. Preferably the oscillator should be set to 4.5MHz with a frequency counter, but adjusting for minimum noise and clarity of sound is usually sufficient.

Of course a multitude of other things could cause audio failure, such as a bad RF converter, strangely defective TIA, or bad solder connections. But the only

time I ever needed to replace anything but the caps was when someone who had worked on the unit previously broke the core out of the sound coil.

Static protection

Due to the CMOS construction of the ICs, static discharges can cause damage even under normal playing conditions. Atari recommends two procedures to minimize this problem. On the CX2600, place 1N4736A zener diodes in shunt across C236 and C237, cathode end toward the hex buffer. This provides protection to the trigger line. An assembly consisting of a paralleled diode and axial capacitor is available as part CA018263 as replacement for C236 and C237.

On both the CX2600 and CX2600A, gummed foil static strips are available that may be affixed to the bodies of the console switches and then to the shield. Thus a ground path is provided for any static charges transferred by the user to the VCS. Installing these parts is a routine procedure recommended for any unit brought in for any reason. The 2600 takes part number CO17294, and the A requires part number CO17297.

There are an estimated two million Atari video game units in the field, and it seems reasonable to postulate that most will fail at least once in a 3-year period. That makes for plenty of business for those who are interested.

Independent servicers can get most of the semiconductor parts for these units from suppliers who advertise in the back pages of electronics and computer magazines. Special custom parts can be ordered from:

Parts Order Service,
1312 Crossman Ave.,
PO Box 61657,
Sunnyvale, CA 94088.

It could be worthwhile to investigate the possibility of becoming a factory-authorized service center. That affords access to service manuals, support bulletins, parts and free advertising.

Let us know how you feel about this article. If it helps you, maybe we can talk more video game troubleshooting in the future.

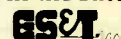

Products

Multiple-outlet box kits

PMC Industries, a manufacturer of multiple-outlet boxes, has just introduced a line of outlet box kits ready for quick, easy assembly by the do-it-yourselfer.

Three models are available, each complete with a 15A resettable circuit breaker, heavy-duty 6-inch 3-wire line cord and appropriate switches, lights and receptacles. Complete instructions, wiring harnesses and all hardware are supplied.

Circle (70) on Reply Card

Wire and tubing cutter

The Cut-A-Length wire and tubing cutter from Dietronix Industries cuts an exact length from 1/2 inch to 48 inches and accepts wire or tubing from 1/16-inch to 3/16-inch inner diameter. The unit has a spring-loaded cutting blade and weighs 3 pounds.

Circle (71) on Reply Card

Technical reference library

RCA Sales Corporation has announced the availability of an RCA Unitized Chassis Technical Reference Library for service technicians.

This binder, with reference index tabs by chassis number, includes RCA workshop manuals, product manuals, troubleshooting and technical tips, and schematics.

"The step-by-step descriptions of troubleshooting procedures found in this reference library isolate common trouble symptoms and their most probable cause," said R. Eugene Eddy, vice president of Warranty Programs and Training for the RCA Sales Corporation.

Circle (69) on Reply Card

Power taps

GC Electronics has announced three new multi-outlet power taps,



in 3-, 6- and 8-outlet models, with a built-in surge-stop feature for positive protection against transient high-voltage spikes and surges. The protective device detects and instantly shunts sudden spikes before they can damage valuable electronic components and systems.

Other features include double-insulated 6-foot power cords, built-in circuit breakers and master on/off switches.

Circle (89) on Reply Card

Logic comparator

The Bugtrap logic comparator, from Bugtrap Instrumentation, has been designed to be used by

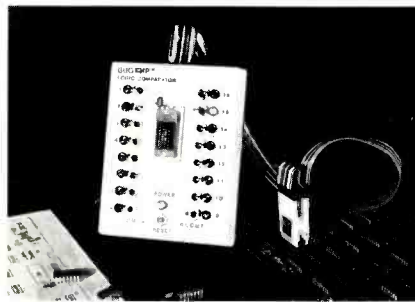

both non-experienced and highly trained technicians.

Because it is often difficult and time consuming to interpret complex digital circuit activity as correct or faulty on an oscilloscope, the Bugtrap logic comparator is an invaluable troubleshooting tool for the digital electronics service industry. The logic comparator tests TTL ICs in circuit at full system speed by comparing the "IC under test" output activity to that of a "known good" IC. The IC under test and the known good or

reference IC (from your stock) share the same system inputs but have their outputs separated and continuously compared. Any discrepancies cause an error signal to be generated and a corresponding LED to be lit and latched to expose the faulty line.

Circle (90) on Reply Card

Temperature monitor

A zero-load temperature monitor has been introduced by Weller for detection of defective elec-



tronic components through heat measurement to resolution of 1°F.

The portable WTT-1000 features a sensing probe with an internal heat source and dual sensor system, measuring both temperature and heat flow without reducing levels of the tested component.

Circle (65) on Reply Card

Surge and dropout protection

Surge Sentry's model SS-120-D from RKS Industries offers reliable protection for equipment susceptible to damage from extreme voltage drops or complete power outages followed by power-up surges.

Designed for 20A circuits, the SS-120-D automatically shuts off when power drops below a safe

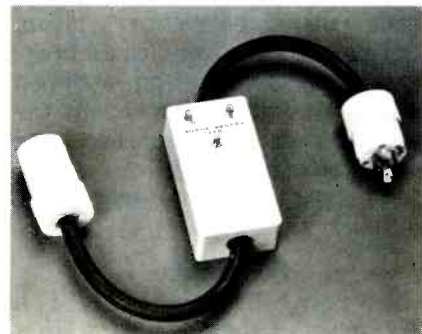

level, so equipment may be checked and properly reset before restoring power. The unit's neon monitor lights indicate at a glance that power dropout has occurred, and a convenient "reset" button permits easy power restoration.

Circle (66) on Reply Card

Soldering tool

An innovation in soldering equipment has been introduced by *Weller*, combining the technology of an electronically controlled



temperature iron with the trigger-quick heat advantage of a gun.

The GEC120, with screw-set constant temperature outputs from 350F to 850F, features built-in circuitry preventing high-voltage spikes on the tip, focused work light, thermoplastic housing and six iron-plated interchangeable tip shapes.

Circle (75) on Reply Card

Wire stripper and cutter

The wire stripper and cutter #WS100C, by *Vaco Products*, accommodates a variety of wire sizes from 12-24 gauge. You simply set the adjustable screw for the wire size needed, and it will hold the stripping die to the proper size for repetitive jobs and prevent nicked wire.

Other features include sharp, flush, cutting edges for a clean, precise cut; stripping dies that perform loop bending on stripped wire; and a spring that opens the tool after each use for ease and quickness of handling.

Circle (76) on Reply Card

Color yoke

The new color yoke (Y267) is a 90-degree deflection yoke that



Thordarson designed as an exact replacement for RCA color yokes 146370-501 (142837) and 1462760-503 (143988).

Circle (77) on Reply Card

LCD DMM

Simpson Electric Company has introduced a new portable LCD digital multimeter, model 467E. Features include peak hold to capture surge currents and voltages, a continuity mode to provide instant visual/audible checks for shorts and opens, and true RMS capability for more significant



measurements of non-sinusoidal waveforms over a wide frequency range.

Circle (78) on Reply Card

Hand-held solder dispenser

A solder dispenser that is said to increase soldering productivity has been introduced by *The Granite Corporation*.

Named "Speedy Feeder," the dispenser feeds out wire solder



when the control wheel is turned. According to Granite, the exceptional feature of Speedy Feeder is that solder can be fed out faster and more continuously than with the fingers.

Feeding by hand requires stoppages to feed out solder and to reposition the solder on the workpiece. Speedy Feeder eliminates these delays and increases soldering output by as much as 30%, according to Granite.

Circle (80) on Reply Card

Delayed sweep oscilloscopes

A 35MHz, delayed-sweep, dual-trace model V-353F joins *Hitachi's* growing family of oscilloscopes.



Featuring six ranges of time-base delay from 1 μ s to 100ms, the V-353F's delayed sweep capability allows for the selection and expansion of a portion of the displayed waveform.

The scope's 5.5-inch CRT has 5.2KV acceleration potential and features an internal graticule and an illuminated scale.

Circle (81) on Reply Card

Bench-top repair system

The *Pace* new PRC-151 repair system is a self-contained system for any rework, repair and modification of printed circuit boards.

The bench-top unit performs scores of repair functions for low-cost, fast and efficient repair of electronic assemblies. The standard system can perform the following repair operations: temperature-controlled desolder-



ing (removal of components), abrading, milling, drilling and grinding for general PCB repair; removal of conformal coatings; high-strength reflow soldering; thermal wire stripping and resistance heating capability.

Circle (86) on Reply Card

Digital storage scopes

Gould Instruments Division has introduced three digital storage oscilloscopes (DSOs). The Gould 1400 series scopes can bring the benefits of digital storage as well as conventional 20MHz scope operation to end users who do not require the higher performance or sophistication of more expensive DSOs.

Circle (79) on Reply Card

Audio test set

The LofTech TS-1 introduces a new concept for basic audio alignment, calibration and testing. The TS-1 is a multipurpose audio test set that incorporates an audio



oscillator, a decibel meter and a frequency counter in a single unit. A booklet is provided to show the user how to perform basic alignment, calibration and testing of audio systems and equipment.

Circle (82) on Reply Card

Wow/Flutter Meter

Leader Instruments has introduced a new wow and flutter/drift meter, model LFM-3610, designed for the service and

testing of turntables, record/playback equipment, VTR and other tape transport devices.

The LFM-3610 has selectable flutter test frequency ranges, which permit the operator to



quickly isolate the trouble area to the capstan, motor or belt.

Circle (83) on Reply Card

Universal locking clips

A new adhesive-backed, latch-free universal locking clip for retaining electrical wiring, tools and small components has been announced by Lija Corporation.

Designed primarily as a wire routing and cable-retention device, the design of the versatile new "Snatcher" clips also lends itself to many component-mounting and other non-electrical applications. An adhesive-backed, flexible-foam mounting surface permits affixing the clips to rough surfaces, while diminishing vibrational effects to cushion objects gripped.

Circle (84) on Reply Card

Circuit analyzer

Non-Linear Systems has added a companion DT-1 component signature analyzer as a companion to their line of miniscopes. The instrument has a capability as an in-circuit tester, producing displays



distinct to the particular component or circuit being tested, without the application of power to the circuit under test. The DT-1 can be used with any oscilloscope equipped with an X-Y input.

Circle (85) on Reply Card

Zener diodes and rectifiers

The Distributor & Special Markets Division of Philips ECG has announced the addition of five

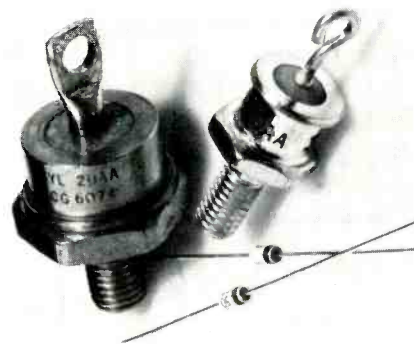

zener diodes and eight rectifiers to the Sylvania ECG semiconductor line.

The zener diodes are used in television and hi-fi equipment, as well as industrial control equipment, and all are half-watt, with 1% tolerance. The rectifiers consist of two Schottky and six conventional stud rectifiers.

Circle (87) on Reply Card

Logic monitor

The LM-2A, a new 16-pin logic monitor specifically designed to monitor 14-pin and 16-pin DIP ICs has been introduced by Global Specialties Corporation.

The new logic monitor simultaneously displays the static and dynamic logic states of 8-, 14- and 16-pin ICs. The included 24-inch cable terminated in a 16-pin Proto Clip IC test clip insures positive contact to the IC under test. By using the LMA-9 optional cable accessory, up to 16 independent points in a system can be monitored.

Circle (88) on Reply Card

BS&T

Now, more than ever
...Men who KNOW say...



IS THE ANSWER

HELP NATESA HELP YOU
BY DOING YOUR PART

Are YOU the operator of an ethical, professional caliber tv-radio-home electronics service business?

Write for details on how you can gain great benefits and participate in the destinies of this great industry.

NATESA
5930 S. Pulaski Road
Chicago, Illinois 60629

MOVING?

If you're planning a move in the near future, don't risk missing an issue of *Electronic Servicing & Technology*. Please give us 6-8 weeks notice if you're planning on changing your address. Just write in your new address below and mail this coupon, WITH YOUR SUBSCRIPTION MAILING LABEL, to:

ELECTRONIC
Servicing & Technology

Subscriber Services
P. O. Box 12901
Overland Park, KS 66212

Name _____

Address _____

City _____

State _____ Zip _____



A.W. Sperry Instruments has made their revised full-line catalog, the MC-399, available. The 12-page, 2-color catalog illustrates and describes in detail the complete line of A.W. Sperry products, which include analog and digital snap-arounds, analog



and digital multimeters, power meters, insulation testers, voltage indicators and accessories.

Circle (100) on Reply Card

The new 48-page *BK-83* full-line test instrument catalog is now available from the **B&K-Precision**

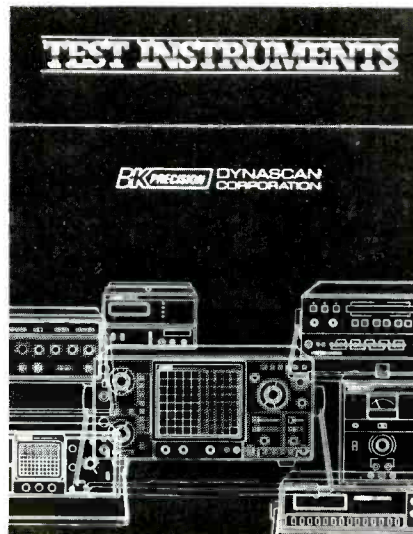

product group of Dynascan Corporation.

New products described in the catalog include oscilloscopes, signature analyzers, logic analyzers, lab-power supplies, DMMs, analog multimeters, digital logic and pulser probes, a temperature probe, semiconductor curve tracer and accessory items.

Circle (101) on Reply Card

World Business Corporation has announced their video products catalog of video and audio products. The catalog includes block converters, UHF/VHF/FM amplifiers, video/VCR/TV switches, down converter with remote control, baluns, splitters, attenuators, line taps, RF modulators, connectors, cables and other video/audio accessories.

Circle (103) on Reply Card

Leader Instruments has announced the availability of their updated 1982/83 test and measurement equipment catalog with 18 new product introductions. The 52-page catalog provides descriptions, photos and specifications of 70 products including oscilloscopes, frequency counters, ac

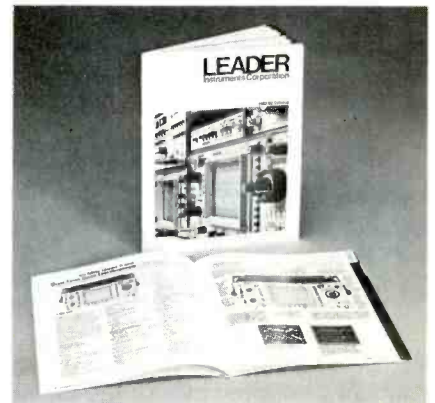

multivolt meters, signal, function and sweep generators, and video and audio test instruments.

Circle (102) on Reply Card

The Wybar Electronics Division of the **Eraser Company** has published a new 24-page catalog describing their range of electronic component lead preparation

and printed circuit board assembly equipment and tools.

The catalog includes technical details of tools and machines for cleaning component lead legs, pre-forming electronic components, IC insertion and printed circuit board assembly. A range of industrial cleaning brushes for cleaning circuit boards and gold edge connector fingers are also included.

Circle (104) on Reply Card

The 9000 series of soldering irons and electronic temperature-controlled soldering systems using Thermo-Duric heating elements is described in a 4-page brochure available from the **Ungar Division** of Eldon Industries.

The illustrated brochure gives specifications and lists interchangeable tips and heaters for the System 9000, System 9100 and System 9200 temperature-controlled systems and the 3-wire grounded System 9300 120V soldering iron.

Circle (105) on Reply Card

An updated *Varian United States Frequency Allocation Chart* is now available from **Varian Associates** Electron Device Group. The chart includes radio, TV, point-to-point, microwave and satellite communications to millimeter wave frequency allocations.

Circle (106) on Reply Card

Speco's new Automotive Antenna and Accessory Catalog (sheet no. ANT-82) has the complete line of Speco automotive antennas for domestic and import cars. The line includes auto radio extension leads, electronic car antennas and boosters, custom AM and FM semi-automatic antennas and CB AM/FM tri-way antennas.

Circle (108) on Reply Card

Topaz Electronics has announced availability of its new ac line-noise suppression reference manual, a basic text on the protection of sensitive electronic equipment from the problems created

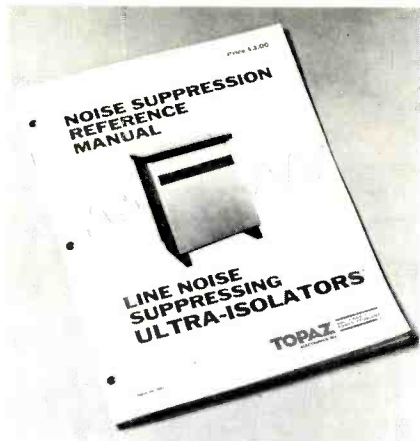

by ac line noise, transients and spikes. The manual covers the basics of ac line noise suppression, provides valuable technical data and includes many typical applications.

Circle (110) on Reply Card

The Engineering Department of the **Electronic Industries Association (EIA)** has announced the availability of RS-490, "Standard Test Methods of Measurement for Audio Amplifiers." This new standard replaces EIA Interim Standard No. 2, which in turn replaced IHF-A-202 (1978) published by the Institute of High Fidelity.

RS-490 is the result of an industry-wide effort to promote standardization in the field of audio amplifier performance measurements.

Copies of RS-490 are \$8 each.

Circle (91) on Reply Card

A new 40-page Printed Circuit Handbook and Accessories Catalog from **GC Electronics** features step-by-step instructions and diagrams and explains in careful detail how to produce professional-quality printed-circuit designs.

This handbook is an enlarged and more complete version of the company's previous edition. It includes a variety of helpful information on how to produce both single- and double-sided printed-circuit boards as well as PC specifications and troubleshooting tips.

Circle (120) on Reply Card



PAT. # 4,259,705

WARNING!
Electric Power Pollution, Spikes, Interference & Lightning HAZARDOUS to HIGH TECH EQUIPMENT!!



MicroComputers, VTR, Hi-Fi, Lasers, Spectrometers are often damaged or disrupted due to Power Pollution.

High Tech components may interact!

Our patented ISOLATORS eliminate equipment interaction, curb damaging Power Line Spikes, Tame Lightning bursts & clean up interference.

Isolated 3-prong sockets; integral Spike/Lightning Suppressor. 125 V, 15 A, 1875 W Total, 1 KW per socket.

ISO-1 ISOLATOR. 3 Isolated Sockets; Quality Spike Suppression; Basic Protection \$69.95

ISO-3 SUPER-ISOLATOR. 3 DUAL Isolated Sockets; Suppressor; Laboratory Grade Protection \$104.95

ISO-17MAGNUM ISOLATOR. 4 QUAD Isolated Sks; Suppressor; Laboratory Grade Protection \$181.95

Master-Charge, Visa, American Express

TOLL FREE ORDER DESK 1-800-225-4876
(except AK, HI, MA, PR & Canada)

SATISFACTION GUARANTEED!

Electronic Specialists, Inc.

171 South Main Street, Natick, MA 01760
Technical & Non-800: 1-617-655-1532

Circle (17) on Reply Card

ESR METER
checks electrolytics
IN-CIRCUIT and is TV shop
FIELD-TESTED:

The most fantastic instrument I've ever bought—Billings, Mt. Used it 3 months; it only missed once—Marinette, Wis. (Typical). Squeal & no sync: 3 bad caps in B+ & AGC; Many Thanks—Taos, N.M. Please ship another; very satisfied—Glen Rock, Pa. It's fantastic—St. Joseph, Mo. Please rush; heard good reports—Hicksville, N.Y. One tremendous meter—Alexandria, Minn. Send your **Super** meter; heard about it—N. Olmstead, Ohio. Love that ESR Meter—Acton, Mass. Used it intensively for 30 days; it's been 100% effective—Pittsburgh, Pa.

Ideal for preventive maintenance: measures electrolyte dryness & shows up intermittent opens.

60-day Satisfaction Guarantee.
Send check or M.O. or call
(313) 435-8916 for COD
Or write for free brochure to:

Creative Electronics
ESR Brochure \$ 99.00
1417 N. Selfridge postpaid
Clawson, Mich. 48017 USA & CAN.

Circle (18) on Reply Card

Marketplace

Put Professional Knowledge and a COLLEGE DEGREE in your Electronics Career through HOME STUDY

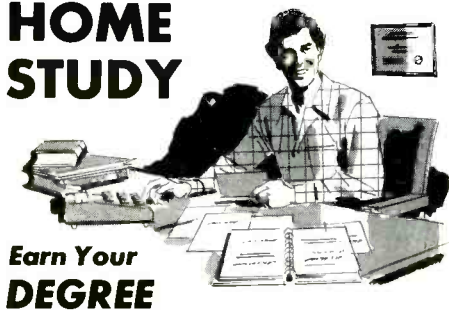

Earn Your DEGREE

No commuting to class. Study at your own pace, while continuing your present job. Learn from easy-to-understand lessons, with help from your home-study instructors whenever you need it.

In the Grantham electronics program, you first earn your A.S.E.T. degree, and then your B.S.E.T. These degrees are accredited by the Accrediting Commission of the National Home Study Council.

Our free bulletin gives full details of the home-study program, the degrees awarded, and the requirements for each degree. Write for *Bulletin T-83*

Grantham College of Engineering
2500 So. LaCienega Blvd.
Los Angeles, California 90034



FREE CATALOG
HARD-TO-FIND PRECISION TOOLS

Lists more than 2000 items: pliers, tweezers, wire strippers, vacuum systems, relay tools, optical equipment, tool kits and cases. Send for your free copy today!

JENSEN TOOLS INC.
7815 S. 46TH STREET PHOENIX AZ 85040

Circle (26) on Reply Card

Your ad gets quick results. Advertise in classifieds.

HOLIDAY SPECIALS

FROM

SPECIAL PRICING GOOD UNTIL 1/31/83

TRITON MARKETING CORP.

EST. 1979

... The Leader In Microwave Entertainment Devices

EARTH STATION BONANZA

A COMPLETE HIGH QUALITY EARTH STATION CONSISTING OF



TELECOM TX-2440 RECEIVER featuring . . .

- Remote dual conversion down converter in a weatherproof housing, horizontal/vertical polarization switch, tunable audio with selectable bandwidth, continuous video tuning, aluminum cabinet, AFC, AGC and a 1 year warranty.

SATELLITE SYSTEMS 10' PARABOLIC

- 4 piece fiberglass construction, 40dB gain, reflector weight approx. 190 Lbs., pole polar mount, hand crank adjustment, LNA mount and rotator, scalar feed horn.

AVANTEK 120° K-50 dB gain LNA.

ALL CABLE, CONNECTORS, HARDWARE and INSTRUCTIONS.

ALL FOR THE INCREDIBLE PRICE OF..... \$ 1985.00

FOB NEW YORK

extra coat options



GILLASPIE 7600A



The Receiver for the Discriminating Videophile

ACTUATORS

Manual & Programmable

LARGER REFLECTOR SURFACES, LOWER LNA NOISE TEMP., ROOF MOUNTED ANTENNAS

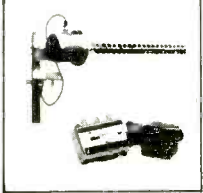
MICROWAVE TV SPECIALS

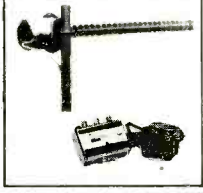
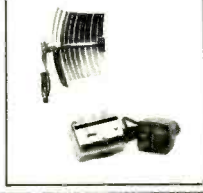
 <p>DCV - 100</p> <ul style="list-style-type: none"> ● Ideal for Medium Signal Areas ● 46 dB System Gain ● 1.9-2.7 GHz ● Built in A/B Switch ● All Cable & Hardware <p style="text-align: center;">== \$ 109.95 ==</p>	 <p>MDC -23D</p> <ul style="list-style-type: none"> ● Commercial Styling ● 2 Microwave Stages ● 53 dB System Gain ● 2.1-2.6 GHz ● Built in A/B Switch ● All Cable & Hardware <p style="text-align: center;">== \$ 149.95 ==</p>
 <p>DCV - 1A</p> <ul style="list-style-type: none"> ● 1 pc. Metal Conet. ● 2 Microwave Stages ● 53 dB System Gain ● 2.1-2.6 GHz ● Built in A/B Switch ● All Cable & Hardware <p style="text-align: center;">== \$ 129.95 ==</p>	 <p>MDC - 23P</p> <ul style="list-style-type: none"> ● 3.75 sq. ft. Parabolic ● 2 Microwave Stages ● 57 dB System Gain ● 2.1-2.6 GHz ● Built in A/B Switch ● All Cable & Hardware <p style="text-align: center;">== \$ 169.95 ==</p>

WE CARRY A COMPLETE LINE OF CABLE TV CONVERTERS & DECODERS

<p>TRITON MARKETING Corp.</p> <p>679 REMSEN AVENUE</p> <p>BROOKLYN, N.Y. 11236</p>	<p>TOLL FREE HOT LINE</p> <p>1-800-221-6535</p> <p>1-212-345-8000</p>
---	--

We Accept Mastercard and Visa

Circle (25) on Reply Card

Opportunity knocks.

The professional world of the Electronics Service Dealer is rough. That's why we're working so hard to make it easier for you to operate a cost effective business. NESDA offers substantial savings on bank-card and insurance rates, business contacts, technical and management certification, and that's just the beginning.

Our members are kept informed about industry developments, and are offered the most comprehensive managerial and technical training programs available. Opportunity knocks. Don't let it pass you by.

For more information about the National Electronics Service Dealers Association, write to: NESDA, 2708 W. Berry St., Ft. Worth, TX 76109.



NAME _____

FIRM NAME _____

FIRM ADDRESS _____ Member of State Local Assn.

CITY _____ STATE _____ ZIP _____ PHONE _____

FREE! FREE! FREE! FREE! FREE!

SEND FOR OUR NEW 1982/1983 PARTS CATALOG

THOUSANDS OF SURPLUS ELECTRONIC PARTS, SUPPLIES AND DEVICES.

ALL ELECTRONICS CORP
905 S. Vermont Ave.
P.O. Box 20406
Los Angeles, Cal. 90006

FREE! FREE! FREE! FREE! FREE!

Circle (21) on Reply Card

Classified

Advertising rates in the Classified Section are 50 cents per word, each insertion, and must be accompanied by payment to insure publication.

Each initial or abbreviation counts a full word.

Minimum classified charge \$10.00.

For ads on which replies are sent to us for forwarding (blind ads), there is an additional charge of \$3.00 per insertion to cover department number, processing of replies, and mailing costs.

Classified columns are not open to advertising of any products regularly produced by manufacturers unless used and no longer owned by the manufacturer or distributor.

For Sale

PRINTED CIRCUIT boards from your sketch or artwork. Affordable prices. Also fun kit projects. Free details. **DANOCINTHS INC** Dept. ES, Box 261, Westland, MI 48185. 5-81-tfn

SONY-PANASONIC-RCA-ZENITH-EXACT REPLACEMENT PARTS-LARGE INVENTORIES-SEND PART OR MODEL NUMBERS-WILL UPS OR COD-GREEN TELE RADIO DISTRIBUTORS, 172 SUNRISE HIGHWAY, ROCKVILLE CENTRE, N.Y. 11570. 5-82-1f

TUBES—Receiving, Industrial and Semi-conductors, factory boxed. Free price list. Low, low prices. **TRANSLETERONIC INC.**, 1365-39th Street, Brooklyn, N.Y. 11218E, 800-221-5802, 212-633-2800. 5-82-1f

2SC1172B's, 50 LOTS—\$1.69; 2SC1308K's, original Sanyos, 50 lots—\$1.99; Cheater cords, 25 lots—35¢; pol- and nonpolarized. 1,000 ft. reels of RG 59 U. Coax Cable—\$39/roll. Minimum order \$75. Redcoat Electronics, 104-20 68th Drive, Forest Hills, NY 11375, 212-459-5088. 10-82-1f

INDIVIDUAL PHOTOFAC FOLDERS (not sets) under #1100. First class postpaid \$3.00. Loeb, 414 Chestnut Lane, East Meadow, NY, 11554. 11-82-3t

SPRING SPECIALS on Popular Electrolytics—40/450V—75¢; 80/450V—85¢; 100/450V—95¢; 200/300V—\$1.05. Quantity 20 lot only. Minimum order of \$50. **SUPER SPECIALS.** Bulk Zenith safety capacitors 800-860, 12 lot only \$2.50 each. **REDCOAT ELECTRONICS**, 104-20 68th Drive, Forest Hills, NY 11375, 212-459-5088. 10-82-tfn

It's no puzzle to order Oelrich Service Forms



For TV-radio and two-way radio service—legal forms for Calif., Florida and Utah. Now at parts jobbers or write for cat. B64.

OELRICH PUBLICATIONS

4040 N. Nashville Ave., Chicago, IL 60634
Now call toll-free! 800-621-0105

For Sale (Cont.)

TV TROUBLE ANALYSIS TIPS. Over 300 symptoms/remedies by circuit area; tough ones over the years. Save time and money. Send \$12.50 to CHAN TV, 8151 Grandview Rd., Chanhassen, Mn. 55317. 5-82-tfn

RUBBER DRIVE BELTS—Lowest prices (26¢ up) brochures free to repair dealers list belts by size, includes cross-reference. Individuals send \$2.00 (credited). Electronic Parts Co., 1015 E. Escondido Blvd., Escondido, CA 92025; (714) 741-2300/3868. 10-82-tfn

TUBES FOR TV AND RADIO—35¢ ea. Washington TV Service, 1330 E. Florence Ave., Los Angeles, CA 90001. 12-82-12t

TUBES—All types, including oldies and hard to find tubes. 2000 different types in stock! SASE for price list. ANTIQUE RADIO & TUBE COMPANY, Dept. 201, 1725 W. University, Tempe, AZ 85281. 12-82-2t

FOR SALE: 1 Heathkit IB-1103 180 MHz frequency counter. 1 IM-2202 3½ digit DVM works on AC or rechargeable batteries. 1 tube tester tests nuvistors miniatures locktats, also tests picture tubes. Set up chart included. Ralph A. Deterling, III, Conant Road, Lincoln, Mass. 01773. 1-83-1t

TV SHOP CLOSED OUT. RETIRED. INVENTORY FOR SALE. LOW PRICE. BOX 425, SAN YSIDRO, CA 92073. 1-83-2t

FOR SALE: B&K 1040 CB Servicemaster (New) \$195.; B&K 2040 CB Generator (New) \$354.; Sencore CB-42 CB Analyzer (New) \$730.; RCA WR50B Signal Generator (Used) \$75. CB Sams Manuals \$5 ea.; TV Sams Photofacts \$2.95 ea. Will Ship COD, UPS, Vic's Electronics, 1024 Studewood, Houston, TX 77008, 1-713-864-6573. 1-83-1t

OVER THREE HUNDRED new T.V. Tubes for sale, half-price. Certified Check or money order. Phone 826-2609 Howard Price, 4102 W. Van Buren St. Chicago, IL 60624. 1-83-1t

B&K TESTERS: Analyst 1476; Tube Tester 700 Picture & Rejuvenator 440. Best offer plus shipping. Oscar Layman, Box 1754, Wickenburg, AZ 85358. 1-83-1t

TUBES FOR TV AND RADIO—35¢ ea. Washington TV Service, 1330 E. Florence Ave., Los Angeles, CA 90001. 1-83-12t

SUBSCRIPTION T.V. MANUAL, covers both the sinewave and gated sync system, only \$12.95. Complete coverage including theory, circuits, waveforms and troubleshooting hints. D & S Enterprises, Box 09292E, Cleveland, Ohio 44109. 1-83-1t

Wanted

WANTED FOR CASH: 50, 53, 6AF6, 6HU8, 304TL, 4CX1000A, 4-1000A, all transmitting, special purpose tubes of Eimac/Varian. DCO, Inc., 10 Schuyler Avenue, North Arlington, New Jersey 07032. Toll Free (800) 526-1270. 5-82-tfn

IDEAS, INVENTIONS, new products wanted now for presentation to industry. Call toll free 1-800-528-6050. In Arizona, call 1-800-352-0458. Extension 831. 11-82-3t

WANTED: Sam's TV Photofacts & MHF Series for new business. Call J. Furtado's TV & Audio Repair Services; 500 Metacom Avenue; Bristol, RI 02809. 1-401-253-3995. 1-83-1t

Business Opportunity

TV TECHNICIANI Increase your income up to \$80,000 yearly. Rent-lease-sell TVs new-used, even from comfort of your home. Basic Preliminaries \$10.00. Perrys TV Systems, Hwy 181, Box 142, Route #1, Bremen, KY 42325. 12-81-tf

MECHANICALLY INCLINED INDIVIDUALS: Assemble

ELECTRONIC TEST EQUIPMENT DESIGN—If you have a degree in electrical engineering, Sencore can use you in its test equipment design lab. We prefer at least two years of practical electronic troubleshooting and experience in test equipment design. Immediate opening, excellent opportunity for the right person in an expanding department. Salary \$18,000 to \$28,000, depending on education and experience. Send resume to: Doug Bowden, Sencore, Inc., 3200 Sencore Drive, Sioux Falls, SD 57107. 1-83-2t

APPLICATION ENGINEER: Due to growth, Sencore has immediate openings for 2 Application Engineers in our Sioux Falls, SD facility. Key responsibilities will include: writing application articles for our monthly 24 page technical publication with national circulation of 100,000, working closely with our design team in new product development and testing, as well as creating effective seminar material including reference material and video tape productions. Successful candidates will have a minimum 2 year formal electronics education, or equivalent, with 4 years desired. Knowledge of digital circuits is a must. Past technical writing is a prerequisite. Good communications skills necessary. This position requires a strong background in test instrumentation and video, communications and general maintenance. At least 2 years practical hands-on experience necessary. Sencore offers a competitive salary, full benefit program, profit sharing, and potential for growth. Located in Sioux Falls, SD, one of America's Top Ten Small Cities. If this sounds like your kind of opportunity, send resume to: Doug Bowden, Sencore, 3200 Sencore Drive, Sioux Falls, SD 57107. 1-83-2t

DEALERS EARN EXTRA PROFIT selling cable TV converters, Video accessories and other great items in our brand new dealer catalog. Request a FREE copy on your letterhead. ETCO, Wholesale Division, Dept. 535, Box 840, Champlain, N.Y. 12919. 9-82-12t

HIGH PROFITS—LOW INVESTMENT: with our CRT rebuilding equipment. Complete training and technical assistance. Guaranteed result. Atoll Television, 6425 W. Irving Park, Chicago, Illinois 60634; PH. 312-545-6667. 12-82-3t

ARIZONA TELEVISION repair business plus three bedroom brick home. Established 20 years. Excellent neighborhood. Nearby repair shop, adjacent lot on one of Tucson's busy avenues. All three properties and business, \$100K. 602-622-2703. 12-82-3t

NORWALK, CALIFORNIA ESTABLISHED TV AND STEREO SERVICE AND SALES very busy money maker, excellent location, low rent, very good lease, 2300 square feet, 10 minutes to beaches and Los Angeles. \$40,000 includes inventory, large enough for living quarters, owner retiring, phone 213-863-1919. 11-82-tfn

TEXAS SUNBELT—Thriving TV & Video Sales & Service. RCA, Zenith, Litton. In booming east Texas area. Total package includes modern custom building, 3000 sq. ft.; display, sales and warehouse with complete inventory; tools, fixtures. On ½ acre. 300 ft. frontage on major highway. Large trade area. Contact Glen Drennan, Agent, 214-675-8856. 11-82-tfn



Readers Service Number

Page Number

21	All Electronics Corp.	63
15	Automated Production Equipment Corp.	40
5	Consolidated Electronics	5
6	The Cooper Group	7
18	Creative Electronics	61
16	Digitron Electronics Corp.	40
	ETA	41
22	ETCO	63
17	Electronic Specialists, Inc.	61
	Grantham College of Engineering	62
24	H & R Communications	41
7	Hitachi Sales Corp. of America	17
12	Inter-Tec	37
26	Jensen Tools Inc.	62
4	Leader Instruments	1
8	Matsushita Engineering & Service Co.	19
	NATESA	60
	NESDA	63
23	Oelrich Publications	63
13	Omnitron Electronics	38
20	Optima Electronics	47
1	PTS Corp.	IFC
	Phillips ECG	15
14	Primefax	39
11	Howard W. Sams & Co.	27
2,3	Sencore	BC
10	Simple Simon Electronic	

ELECTRONIC

Service & Technology

Advertising Sales offices

NATIONAL SALES MANAGER

Greg Garrison
P.O. Box 12901
Overland Park, KS 66212
Phone: (913) 888-4664

LONDON, ENGLAND

*John Ashcraft & Co.,
John Ashcraft*
12 Bear Street, Leicester Square
London WC2H 7AS, England
Phone: 930-0525 Telex: 895-2387

AMSTERDAM, Holland

*John Ashcraft & Co.
John J. Lucassen*
Akerdijk 150A
1171 PV-Badhoevedorp, Holland
Phone: 0-2968-6226 Telex: 18406 HARKE NL

TOKYO, JAPAN

*International Media
Representatives, Ltd.
Sumio Oka*
2-29, Toranomon 1-chome
Minato-ku, Tokyo 105, Japan
Phone: 502-0656

Don't touch that connection!

New Zenith push-button VIDEO ORGANIZER permits switching from one program source to another without changing cable connectors. Lets you select up to six different program sources for viewing. Up to three different sources for recording. Even lets you view one program source while simultaneously recording another. All this without changing cable connections!

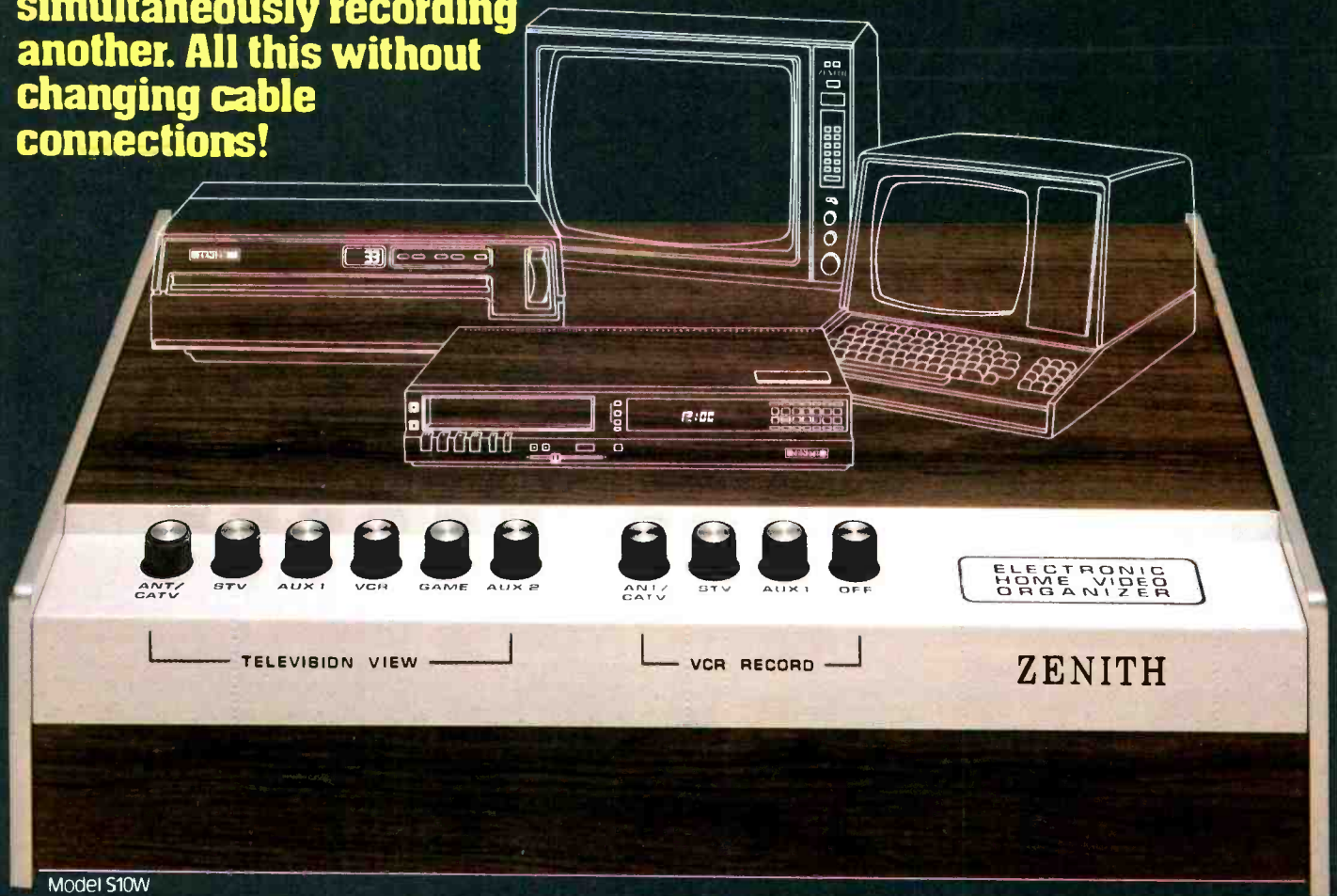

At last the nuisance of manually changing cable connections is a thing of the past!

With Zenith's new video Organizer, separate input and output jacks enable you to make a complete connection of TV and VHF antenna or cable TV antenna, subscription TV decoder, video disc player, video cassette recorder, video game and home computer or other auxiliary video equipment.

So you switch from one program

source to another with pushbutton ease – without changing connections.

Equally important, the Video Organizer's advanced engineering design by Zenith results in low insertion loss and high isolation. Eliminates electromagnetic interference for maximum picture quality. And permits greater flexibility in use and ease of operation for more hours of uninterrupted home video enjoyment.

Write now for more information!

ZENITH
®
The quality goes in before the name goes on.™

Zenith Radio Corporation/Service, Parts & Accessories Division/11000 Seymour Avenue/Franklin Park, Illinois 60131

Cut Your Service Time Absolutely In Half Or Your Money Back.

Sencore SC61 60 MHz Waveform Analyzer

If you use a general purpose oscilloscope for troubleshooting we can cut your present service time in half with the SC61 Waveform Analyzer.

It's ten times faster—ten times more accurate: The SC61 is the first and only instrument to integrate the speed and accuracy of a digital readout with the viewing capability of a high performance 60 MHz scope. Connect only one probe and you can view any waveform to 60 MHz. Then, just push a button to read DCV, PPV, frequency and time.

There are no graticules to count or calculations to make so every measurement is 10 to 100 times faster than before.

The digital readout is 10 to 10,000 times more accurate than conventional

scopes as well, for measurements you can trust in today's high precision circuits.

Plus having everything you want to know about a test point, at the push of a button, eliminates guesswork and backtracking

A special Delta function even lets you intensify any part of a waveform and digitally measure the PPV, time or frequency for just that waveform section. This really speeds VCR alignment and calibration procedures

And it's neat: No more tangled

leads, piles of probes or dangling cords. The SC61 is an entire service bench in one unit. You can't get neater than that.

Cut your service time in half: When we say the SC61 will cut your service time in half, we're being conservative. We know of cases where the SC61 has saved much more time than that. Every situation is different, however, so try an SC61 and judge for yourself. Here's our offer.

Money back guarantee: If the SC61 does not at least cut your present service time in half during the first thirty days, you may return it for a full refund, including freight both ways.

Call today. Get the entire SC61 Waveform Analyzer story. Call toll-free today, and ask for our eight page color brochure. It could be the most time-saving call you make this year!

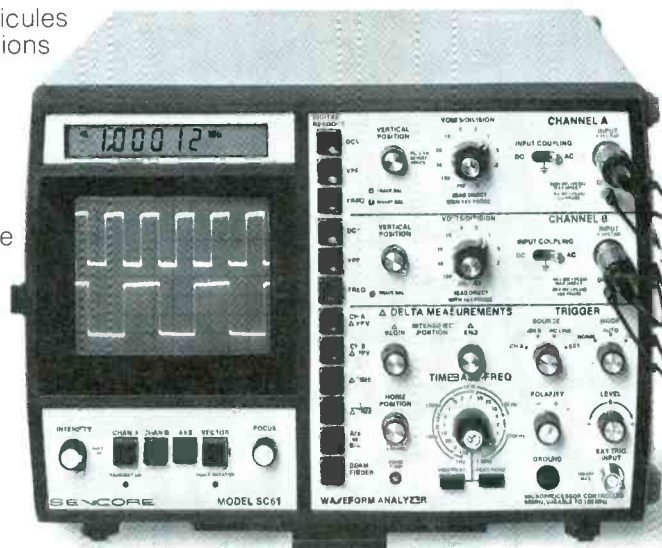

\$3275

SENCORE
3200 Sencore Drive, Sioux Falls, SD 57107

Phone Toll-Free 800-843-3338
Alaska, Hawaii, Canada and SD call collect at (605) 339-0100

For Information Circle (2) on Reply Card
For Demonstration Circle (3) on Reply Card